

AVerMedia®
NX 8000 series

User Manual

FCC NOTICE

This device complies with Part 15 of the FCC Rules. Operation is subject to the following two conditions: (1) this device may not cause harmful interference, and (2) this device must accept any interference received, including interference that may cause undesired operation.

Federal Communications Commission Statement

NOTE- This equipment has been tested and found to comply with the limits for a Class A digital device, pursuant to Part 15 of the FCC Rules. These limits are designed to provide reasonable protection against harmful interference in a residential installation. This equipment generates uses and can radiate radio frequency energy and, if not installed and used in accordance with the instructions, may cause harmful interference to radio communications. However, there is no guarantee that interference will not occur in a particular installation. If this equipment does cause harmful interference to radio or television reception, which can be determined by tuning the equipment off and on, the user is encouraged to try to correct the interference by one or more of the following measures:

- Reorient or relocate the receiving antenna.
- Increase the separation between the equipment and receiver.
- Connect the equipment into an outlet on a circuit different from that to which the receiver is connected.
- Consult the dealer or an experienced radio/television technician for help.

CE NOTICE

This product is herewith confirmed to comply with the requirements set out in the Council Directives on the Approximation of the laws of the Member States relating to Electromagnetic Compatibility Directive 2004/108/EEC.

Warning - This is a Class A product. In a domestic environment this product may cause radio interference in which case the user may be required to take adequate measures to correct this interference.

DISCLAIMER

No warranty or representation, either expressed or implied, is made with respect to the contents of this documentation, its quality, performance, merchantability, or fitness for a particular purpose. Information presented in this documentation has been carefully checked for reliability; however, no responsibility is assumed for inaccuracies. The information contained in this documentation is subject to change without notice.

In no event will AVerMedia® be liable for direct, indirect, special, incidental, or consequential damages arising out of the use or inability to use this product or documentation, even if advised of the possibility of such damages.

TRADEMARKS

AVerMedia, being authorized AVerMedia Information, Inc. to use, is registered trademarks of AVerMedia TECHNOLOGIES, Inc. IBM PC is a registered trademark of International Business Machines Corporation. Macintosh is a registered trademark of Apple Computer, Inc. Microsoft is a registered trademark and Windows is a trademark of Microsoft Corporation. All other products or corporate names mentioned in this documentation are for identification and explanation purposes only, and may be trademarks or registered trademarks of their respective owners.

COPYRIGHT

2008 by AVerMedia® TECHNOLOGIES, Inc. All rights reserved. No part of this publication may be reproduced, transmitted, transcribed, stored in a retrieval

system, or translated into any language in any form by any means without the written permission of AVerMedia® TECHNOLOGIES, Inc.

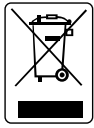

Following information is only for EU-member states:

The use of the symbol indicates that this product may not be treated as household waste. By ensuring this product is disposed of correctly, you will help prevent potential negative consequences for the environment and human health, which could otherwise be caused by inappropriate waste handling of this product. For more detailed information about recycling of this product, please contact your local city office, your household waste disposal service or the shop where you purchased the product.

Table of Contents

Chapter 1	Introduction.....	1
1.1	Package Contents	1
1.1.1	4/8/16 Channels.....	1
1.1.2	32 Channels.....	1
1.2	Card Parts	1
Chapter 2	Hardware Installation	2
2.1	Minimum System Requirements.....	2
2.2	Installing NX8004/NX8008/NX8016 Card.....	2
2.3	Installing NX8032 and I/O card.....	3
2.4	Connecting the Watchdog line.....	3
2.5	Connecting the a TV, Audio device, Sensor and Relay device.....	4
2.6	Dual Monitors Setup.....	5
2.6.1	Graphic card with ATI chipset.....	5
2.6.2	Graphic card with NVIDIA chipset.....	7
2.7	Sensor and Relay pinhole allocation on NX8000	8
2.7.1	Connecting the Sensor/Relay device to I/O card.....	8
2.7.2	I/O Card Sensor and Relay pinhole allocation:.....	8
2.8	The Sensor input and Relay output Specifications.....	9
2.9	Connecting POS (Point of Sales)	9
Chapter 3	Software Installation.....	11
3.1	Installing DVR Software in Windows XP/2000	11
Chapter 4	Using the DVR Software.....	13
4.1	Running the DVR Software	13
4.2	Using the Virtual Keyboard.....	13
4.3	Familiarizing the Buttons in Preview/Advanced Mode	14
4.3.1	Using Event Log Viewer.....	16
4.4	Familiarizing the Buttons in Compact Mode.....	17
4.5	Familiarizing the Buttons in Playback Mode.....	18
4.6	Familiarizing the Buttons in PTZ Camera Controller	21
4.7	Setting Up and Using the Emap	21
4.7.1	To Set Up the Emap.....	21
4.7.2	To Use the Emap	22
4.8	To Cut and Save the Wanted Portion of the Recorded Video	23

4.9	To Bookmark a Section of the Video	23
4.10	To Search Using the Visual Search	23
4.11	To Search Using the Event Search	24
4.12	To Search Using the Intelligent Search	24
4.13	To Setup the PTZ/IP PTZ Camera.....	25
Chapter 5	Customizing the DVR System	28
5.1	System Setting	28
5.1.1	To Set the POS Setting:	35
5.2	Camera Setting.....	41
5.2.1	Setup the Object Counting.....	44
5.3	Recording Setting.....	45
5.3.1	To Mask/Shield an area on the screen:.....	47
5.3.2	To show and change the color of the Mask:	47
5.3.3	To Playback Encrypted Video:	47
5.4	Network Setting	48
5.5	Schedule Setting	50
5.5.1	To set schedule at a specific portion of time in that hour:	51
5.6	Backup Setting	52
5.7	Sensor Setting.....	53
5.7.1	To Setup External I/O Box.....	54
5.8	Relay Setting	56
5.9	Alarm Setting.....	57
5.9.1	To Setup Alarm Relay:	61
5.9.2	To Setup the Alarm Sound Setting:	62
5.9.3	To Setup Call Out List:	62
5.9.4	To Setup Send E-mail Setting:	63
5.9.5	To Setup FTP Setting:	63
5.9.6	To Setup Alarm Recording Setting:.....	64
5.9.7	To Setup SMS/MMS Setting:	64
5.9.8	To Setup PTZ Preset Point:	65
5.9.9	To Setup Alarm SOP:	65
5.9.10	To Setup CMS Setting.....	65
5.9.11	To Setup POS Keyword Setting	65
5.9.12	Missing, Suspicious Object, and Scene Change Detected.....	66
5.10	User Setting.....	69

Chapter 6	Backup Video Players	71
6.1	Familiarizing QPlayer Buttons	71
Chapter 7	Using Functional Keys	74
Chapter 8	Using the Remote Programs	75
8.1	Familiarizing the DVR WebViewer Buttons	76
8.1.1	To Setup Remote System Setting	78
8.2	Familiarizing the WebViewer PTZ Buttons	79
8.3	Familiarizing the Remote Console Buttons	80
8.3.1	To Setup Remote Console Setting	81
8.4	Familiarizing the Buttons in PTZ Camera Controller	82
8.5	Using the Remote Playback	83
8.5.1	Familiarizing the Local Playback Buttons	84
8.5.2	Familiarizing the RealTime Playback Buttons	86
8.5.3	Familiarizing the Download and Playback Buttons	88
8.6	Using HandyViewer to Access DVR server	89
8.7	Using PDAViewer to Access DVR Server	89
8.7.1	To install PDAViewer thru ActiveSync	90
8.7.2	To install PDAViewer from the Internet	91
8.7.3	To Use the PDAViewer	92
8.7.4	To Playback in PDAViewer	93
8.8	Using JavaViewer to Access DVR Server	94
8.8.1	To install JAVAViewer from the DVR Server	94
8.8.2	To Use the JAVAViewer	95
Chapter 9	Image Verification	97
9.1	To Run the ImageVerification program	97
Chapter 10	iEnhance	98
10.1	To Use iStable	99
Chapter 11	Web Tools	101
11.1	Dispatch Server	101
11.2	Remote Backup	101
Chapter 12	Using the Remote Control Server	104
Appendix A	Registering Domain Names	105
Appendix B	Configure UPnP	106
	Enabling UPnP in Window XP	106
Appendix C	Network Service Port	108
	LIMITED WARRANTY	109

Manual Conventions

The following conventions are used throughout this manual.



Caution symbol is intended to alert the user of the important installation and operating instructions. Fail to comply may damage the system.



Information symbol is intended to provide additional information for the purpose of clarification.

NOTICE:



- INFORMATION IN THIS DOCUMENT IS SUBJECT TO CHANGE WITHOUT NOTICE.
 - THE INFORMATION CONTAINED HEREIN IS TO BE CONSIDERED FOR REFERENCT ONLY.
-

Chapter 1 Introduction

AVerMedia AVerDVR is a 32-bit PCI-E video capture card that works as a digital video surveillance system. It enables you to capture true color images and real-time videos up to 32 IP camera inputs simultaneously.

With the latest Motion Detection technology, you no longer need to monitor every single moment of the day; the system automatically records and triggers an alarm when any movement is detected.

1.1 Package Contents

1.1.1 4/8/16 Channels

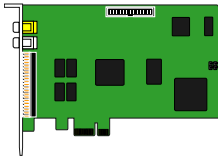

(1)

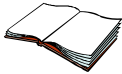

(2)



(3)



(4)

- (1) NX8000
- (2) Quick Guide

- (3) Installation CD (manual is included)
- (4) 30cm Watchdog line

1.1.2 32 Channels

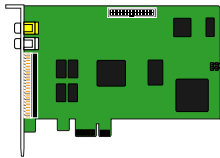

(1)



(2)

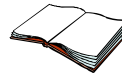

(3)



(4)



(5)



(6)

- (1) NX8000
- (2) I/O card
- (3) Quick Guide
- (4) Installation CD (manual is included)
- (5) 30cm Watchdog line
- (6) I/O cable



If there is any damage, shortage or inappropriate item in the package, contact your local dealer immediately.

1.2 Card Parts

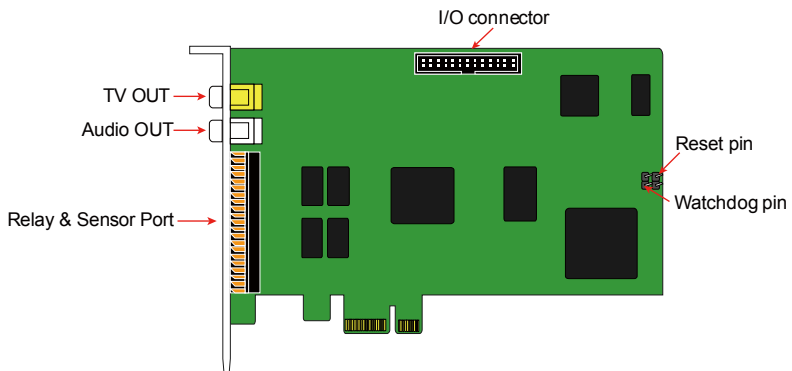

Chapter 2 Hardware Installation

2.1 Minimum System Requirements

First, must verify if the computer meets the minimum system requirements.

CPU	Pentium® 4 2.8GHz or above recommended
Motherboard	Intel 875, 915, 925, 945, 955, NVIDIA nFORCE4 SLi - Intel Edition chipset
OS	Windows2000 Professional or Windows XP Professional
Expansion Slots	PCI-Ex1 Slot
RAM	DDR 512MB or above
Hard disk	120GB of free hard disk space, or at least 60GB free space for each partition
Media	CD-ROM drive
VGA	16-bit high color SVGA graphic card with DirectDraw & YUV rendering capability, 64MB video memory
Audio	Sound card and speakers



For AVerMedia® Security Product Hardware Recommendation list update, go to :

<http://www.avermedia.com/AVeDiGi/Product/Detail.aspx?Id=83&Tab=SystemRequirement>.

2.2 Installing NX8004/NX8008/NX8016 Card

1. Remove the PC case cover.
2. Remove 1 bracket that covers the PCI slots. Save the screws.
3. Press the cards into the PCI-Ex1 slots firmly.
4. Secure the card with the screws.

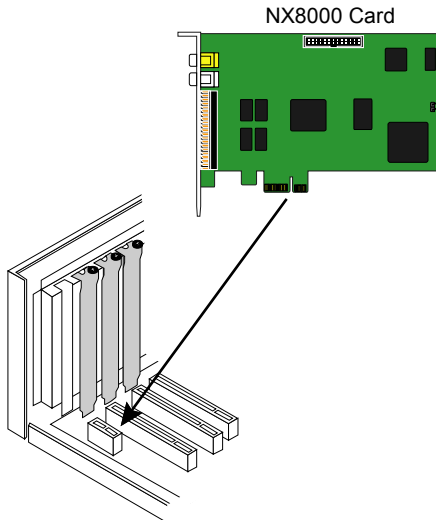

2.3 Installing NX8032 and I/O card

1. Remove the PC case cover.
2. Remove 2 brackets that cover the PCI slots. Save the screws.
3. Connect the NX8032 card and I/O card with the connection cable.
4. Press the cards into the PCI-Ex1 slots firmly.
5. Secure the card with the screws.

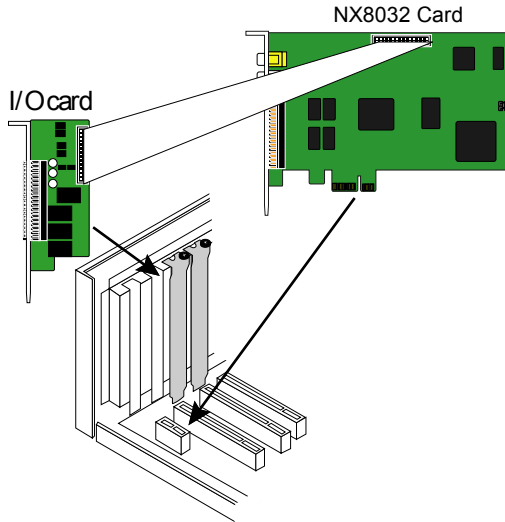

2.4 Connecting the Watchdog line

Connecting the NX8000 to the motherboard reset switch panel, enables the unit to restart automatically and reset the system when an error has been detected.

1. Look for the labeled RESET SW switch lead and connect it to the NX8000 card reset pin.
2. Connect the supplied Watchdog line to the NX8000 card watchdog pin and the other end to the motherboard RESET SW panel. If you are not sure, please refer to the motherboard user manual.
3. You may now replace back the PC cover and connect all the cables.

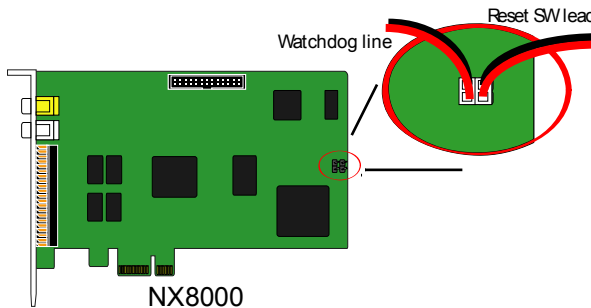

2.5 Connecting the a TV, Audio device, Sensor and Relay device

1. Connect one end of the RCA video cable (not supplied) to the TV OUT port and the other end to the TV video input port. If you are not sure, please refer to the TV user manual.
2. Connect the audio devices to the Audio input port.
3. Connect the sensor and relay device to the sensor/relay interface.

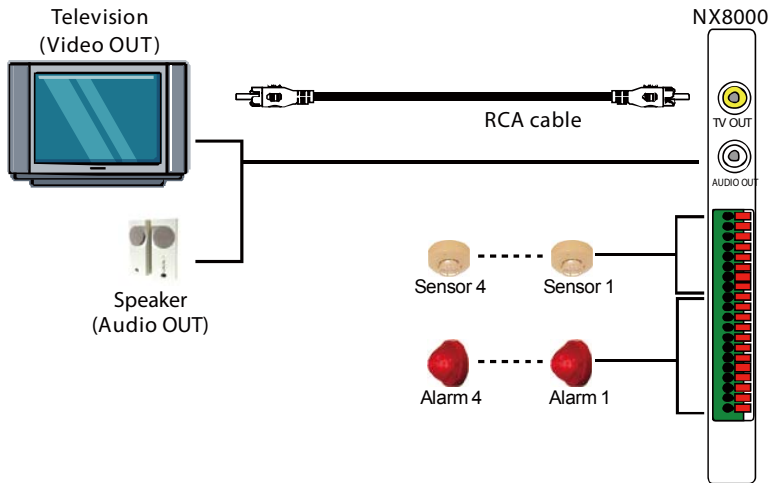

To connect the cameras, please refer to [Chapter 5.2](#).

2.6 Dual Monitors Setup

The DVR system Supports Single and Dual monitor displays. When using dual monitors, the E-map and Playback function will be display on the second monitor. The Video configuration is different for each different VGA chipsets. Please follow the steps below to setup the dual monitors display.

2.6.1 Graphic card with ATI chipset

1. Enter the ATI Catalyst Control Center, user can click the short-cut or right click on the screen.



2. There are two modes to select — Basic and Advanced.



3. If user selected Basic mode, press the **Quick Settings** tab. Then select the **Select a different desktop mode** and click **Go**.

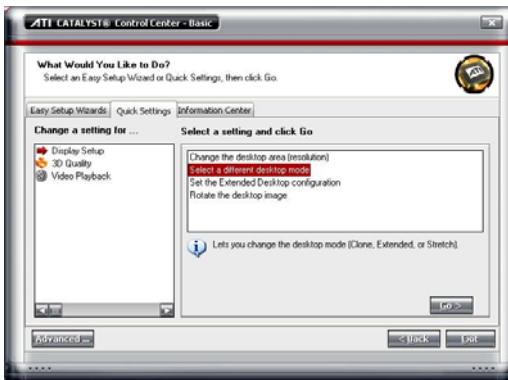

4. Select the **Extended Desktop** and then click **Finish**.

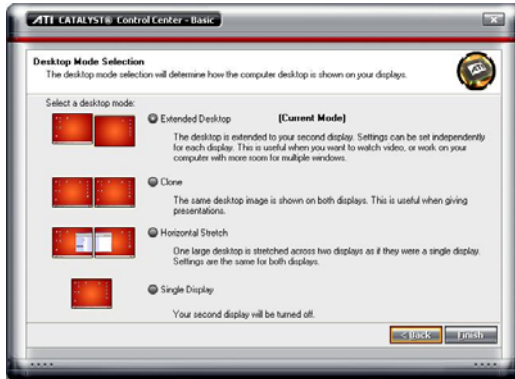

5. If user selected the **Advanced** mode, click the **View** button.
6. In **Display Manager**, right click on the second Display on the right side and select **Extend Main onto monitor**.



7. Adjust each monitor resolution to 1024x768.

2.6.2 Graphic card with NVIDIA chipset

1. Click the NVIDIA nView, and select the **Dualview** mode.
2. Adjust each monitor resolution to 1024x768.

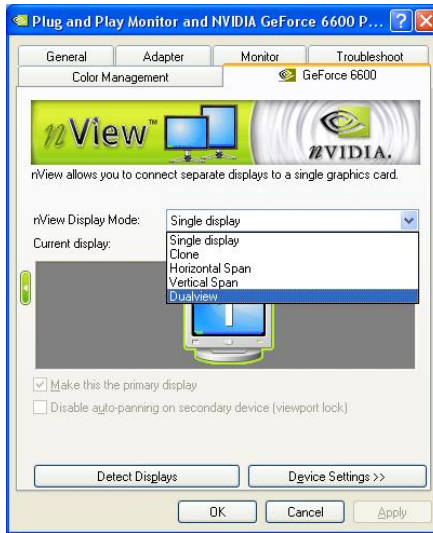

3. To review if the display mode is correct, you can check the task bar. The task bar will show on the first monitor only.



Monitor 1

Monitor 2

2.7 Sensor and Relay pinhole allocation on NX8000

The signal from the sensor (i.e., infrared sensors, smoke detectors, proximity sensors, door sensors, etc.) is being transmitted to the I/O card, and this triggers the system to respond and send signal to relay device (i.e., alarm, telephone etc).

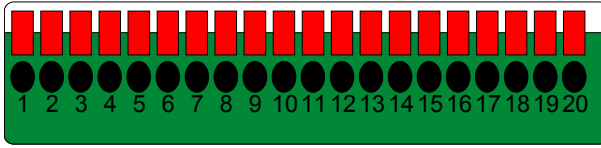

Pin #	Definition	Pin #	Definition
1	Sensor input signal 1+	11	Relay Normal Close 1
2	Sensor output signal 1-(GND)	12	Relay Common 2
3	Sensor input signal 2+	13	Relay Normal Open 2
4	Sensor output signal 2-(GND)	14	Relay Normal Close 2
5	Sensor input signal 3+	15	Relay Common 3
6	Sensor output signal 3-(GND)	16	Relay Normal Open 3
7	Sensor input signal 4+	17	Relay Normal Close 3
8	Sensor output signal 4-(GND)	18	Relay Common 4
9	Relay Common 1	19	Relay Normal Open 4
10	Relay Normal Open 1	20	Relay Normal Close 4

2.7.1 Connecting the Sensor/Relay device to I/O card

The I/O Audio card enables you to connect (4) sensor inputs and (4) relay outputs. Just connect the external sensor and relay pin directly to the pinhole on the NX8000 card. Check the table below and locate which pinhole is assigned to sensor input and relay output.

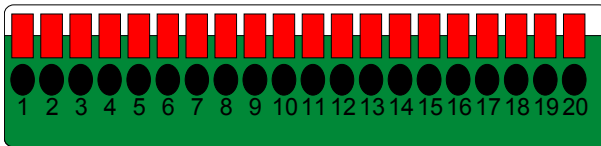

2.7.2 I/O Card Sensor and Relay pinhole allocation:

The signal from the sensor (i.e., infrared sensors, smoke detectors, proximity sensors, door sensors, etc.) is being transmitted to the I/O card and this triggers the system to respond and send signal to relay device (i.e., alarm, telephone etc).

Pin #	Definition	Pin #	Definition
1	Sensor input signal 1+	11	Relay Normal Close 1
2	Sensor output signal 1-(GND)	12	Relay Common 2
3	Sensor input signal 2+	13	Relay Normal Open 2
4	Sensor output signal 2-(GND)	14	Relay Normal Close 2
5	Sensor input signal 3+	15	Relay Common 3
6	Sensor output signal 3-(GND)	16	Relay Normal Open 3
7	Sensor input signal 4+	17	Relay Normal Close 3
8	Sensor output signal 4-(GND)	18	Relay Common 4
9	Relay Common 1	19	Relay Normal Open 4
10	Relay Normal Open 1	20	Relay Normal Close 4

2.8 The Sensor input and Relay output Specifications

You may use the sensor input and relay output specifications table below for your reference.

A. Sensor Input Specification

Absolute Maximum Ratings

(Ta=25°C)

Parameter		Symbol	Rating	Unit
Input	Forward Current	I_F	50	mA
	Reverse Voltage	V_R	6	V
	Power Dissipation	P	70	mW

Electrical/Optical Characteristics

(Ta=25°C)

Parameter		Symbol	Min	Typ.	Max.	Unit	Conditions
Input	Forward Current	V_F	-	1.2	1.4	V	$I_F=20mA$
	Reverse Voltage	I_R	-	-	10	A	$V_R=4V$
	Terminal Capacitance	C_t	-	30	250	pF	$V=0, f=1KHz$
Parameter		Symbol	Min	Typ.	Max.	Unit	Conditions
Output	Collector Dark Current	I_{CEO}	-	-	100	nA	$V_{CE}=20V$
	Collector-Emitter Breakdown Voltage	BV_{CEO}	35	-	-	V	$I_C=0.1mA$
Output	Emitter-Collector Breakdown Voltage	BV_{ECO}	6	-	-	V	$I_E=10 A$
	*Current Transfer Ratio	CTR	50	-	600	%	$I_F=5mA, V_{CE}=5V R_{BE}=\infty$
Transfer Characteristics	Collector Current	I_C	2.5	-	30	mA	
	Collector-Emitter Breakdown Voltage	$V_{CE(sat)}$	-	0.1	0.2	V	$I_F=20mA, I_C=1mA$
	Isolation Resistance	R_{ISO}	5×10^{10}	10^{11}	-		DC500V, 40-60% R.H.
	Floating Capacitance	C_f	-	0.6	1.0	pF	$V=0, f=1MHz$
	Cut-off Frequency	f_c	-	80		KHz	$V_{CE}=5V, I_C=2mA$ $R_L=100, -3dB$
	Response Time (Rise)	t_r	-	4	18	s	$V_{CE}=2V, I_C=2mA$
Response Time (Fall)	t_f	-	3	18	s	$R_L=100$	

$$*CTR = \frac{I_C}{I_F} \times 100\%$$

B. Relay Output Specification

Surge strength	:1500 VAC
Nominal power	: 200mw ~ 360mw
Operating power	: 110mw ~ 200mw

C. COIL RATINGS (at 20 oC)

Coil Nominal Voltage (VDC)	Coil Resistance 10%	Pick-up Voltage (VDC)	Drop-Out Voltage (VDC)	Nominal Current (mA)
5	125	3.75	0.5	40

* Max Continuous Voltage at 20°C : 110% of Coil Nominal Voltage

D. CONTACT RATINGS

Contact Arrangement	1 Form C (SPDT)
max. Switch Power	125VA 60W
max. Switch voltage	125VAC 30VDC
max. Switch current	1A
Contact Resistance	≤ 100mΩ
Resistive Load	1A/125VAC 1A/30VDC

2.9 Connecting POS (Point of Sales)

AVerMedia® AVerDVR can be integrated with POS system equipment. Connecting the POS equipment to AVerMedia® AVerDVR system thru RS232 connection, enables you to view, record and keep track of the items that were sold. You may also select the camera on where to display all the data. To connect, locate the RS232 port of the POS equipment and PC. Use an RS232 cable (not supplied) to make the connection.



RS232 cable

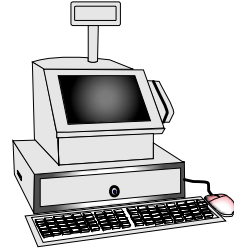

For detail of POS installation, please refer to POS Quick Guide.

Chapter 3 Software Installation

This chapter describes how to install the DVR software.



The CD-Key is permitted for use on a single computer. It is prohibited to use the CD-key on more than one computer. Once detected, this would cause a system conflict and some of the features might fail to work on both PC.



Before installing the software, make sure that the Windows OS patches and the video graphic card driver are **UPDATED**.



If you have an old version of the DVR software installed in your PC, the old copy must be removed. To remove, click **Start>Settings>Control Panel** and then double click **Add/Remove Programs**. In Add/Remove Programs list, select **NV DVR** and then click **Remove**.



We **HIGHLY RECOMMEND** having three (3) separate drives for the main system (OS and DVR software), storage and backup. The ideal hard disk size for the main drive is 20GB. As for the storage and backup, at least 60GB each. The hard drives format must be in **NTFS**. This way we can maintain an optimized system for your security.



For Windows 2000, make sure the hyper-threading setting is **DISABLED** from the PC BIOS system.



To ensure getting the latest copy of DVR software, go and download the updated version from the following site:

Worldwide :

http://www.avermedia.com/cgi-bin/support_download.asp

US/CANADA:

<http://www.aver.com> (click on Support)

3.1 Installing DVR Software in Windows XP/2000



Upon turning the computer on, the system automatically detects the newly installed hardware. When the **Found New Hardware** dialog box appears, **IGNORE** it.

Remember : It is important to install the DVR software first, before installing the drivers.

1. Place the installation CD into the CD-ROM drive then click **Install Surveillance System**. And follow the on-screen instructions.



2. **For Windows XP:**

When the Install Driver notice appears, this informs you that you are about to install the drivers. This may take a while depending on the number of drivers needed to be installed. Click **“Continue Anyway”** when the Microsoft digital signature appears.

When prompt to restart the computer, select **Yes, I want to restart my computer now** then click **Finish**.

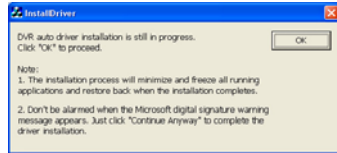

For Windows 2000:

When prompt to restart the computer, select **Yes, I want to restart my computer now** then click **Finish**. This time you have already installed the DVR software.

After rebooting, the system again detects the newly installed hardware. When the Microsoft digital signature appears, Click **OK** to complete the installation.

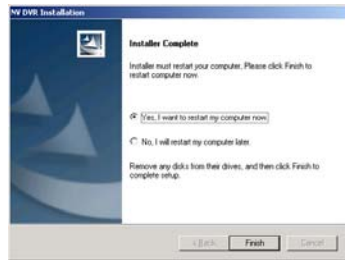

3. You may now run the DVR program. To run the application, click  on your PC desktop or click **Start>Programs>DSS>NV DVR**.

Chapter 4 Using the DVR Software

4.1 Running the DVR Software

To run the application, double-click  on your PC desktop or click **Start>Programs >DSS>NV DVR**.

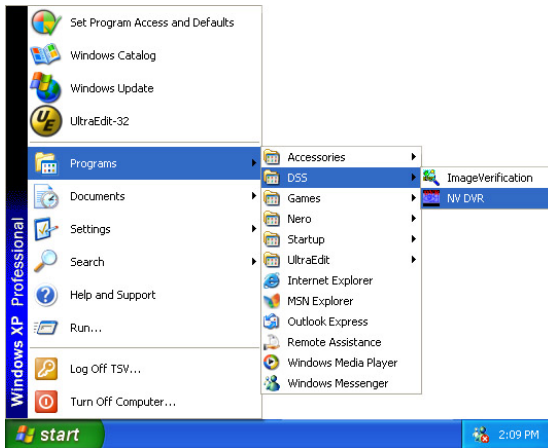

For security purpose, some of the features would require you to enter User ID and Password before it can be accessed. When the Authorization dialog box appears, key in your User ID and Password. (If this is the first time, enter the one you have registered when installing the software.)

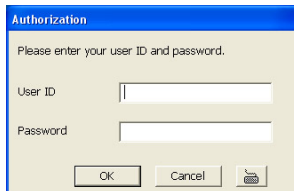

4.2 Using the Virtual Keyboard

If the keyboard is not available, you may use the Virtual Keyboard. Just click  to show the virtual keyboard. For uppercase and lowercase, click **shift** button.



4.3 Familiarizing the Buttons in Preview/Advanced Mode

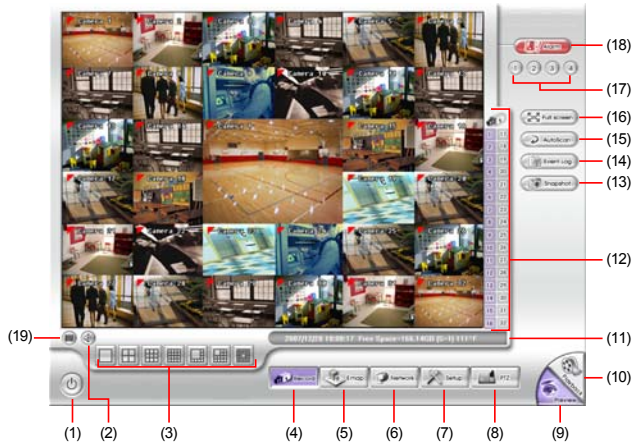

Name	Function
------	----------

(1) Exit

Call up the Logout dialog box.

In the logout dialog box, you may do the following:

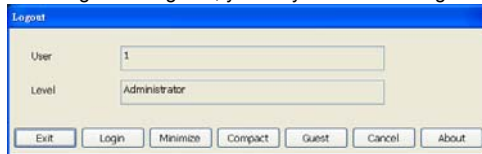

- Click **Exit** to close the DVR program.
- Click **Login** to sign-in in different account.
- Click **Minimize** to reduce the DVR to taskbar button.
- Click **Compact** to switch to compact mode (see [Chapter 4.4](#)).
- Click **Guest** to switch to the guest mode. In guest mode, the functions are limited to preview and playback function only. For complete functions of DVR, please login as an administrator.
- Click **Cancel** to exit Logout dialog box.
- Click **About** to update patch or find about the software info.

(2) Volume

Adjust the sound volume.

(3) Split Screen Mode

Select from 7 different split screen types to view all the camera, or one camera over the other or alongside on a single screen. It also allows you to switch and view different camera number.



- If there are only 4 cameras, you won't be able to switch to 9, 16, 13, and 32 split screen mode.
- The DVR system will save the current operating mode (split screen mode, auto scan, full screen, and compact mode status) when shutdown DVR application and apply the mode for next login.
- When you are in single screen mode, **Right click** and **Drag** a square on the area you want to enlarge.
- When you are in multiple-screen mode, **Right click** the video screen of the camera and **Drag** on where you want to relocate it. To only display one of the video in the multiple-screen mode, **Left click** on the video screen you only want to display.

(4) Record

Start/stop video recording.

Name	Function
(5) Emap	Display the map in each area, and the location of camera/ sensor/ relay and the warning. (see also Chapter 4.7)
(6) Network	Enable/disable remote system access. This feature allows you to access DVR server from a remote location via internet connection. (see also Chapter 8)
(7) Setup	Configure the system settings. (see also Chapter 5)
(8) PTZ	Access PTZ control panel. Beside PTZ camera, DVR system also support mega pixel IP camera. (see also Chapter 4.6).
(9) Preview	Switch to Preview/Advanced mode. This allows you to view live camera display.
(10) Playback	Switch to Playback mode. This allows you to view the recorded video file. (see Chapter 4.5)
(11) Status Bar	Display the current date, time and hard disk free space.
(12) Camera ID	Show the number of cameras that are being viewed. When you are in single screen mode, click the camera ID number to switch and view other camera.
(13) Snapshot	Capture and save the screen shot either in *.jpg or *.bmp format.
(14) Event log	Show the record of activities that take place in the system. (also see Chapter 4.3.1)
(15) AutoScan	Start/Stop video screen cycle switch. (see also Chapter 5.1 #6)
(16) Full screen	Use the entire area of the screen to only display the video. To return, press the right button of the mouse or ESC on the keyboard or click the arrow icon.
(17) Alarm Button	<div data-bbox="308 762 840 1161" data-label="Image"> </div> <p data-bbox="845 786 991 938">Click the arrow icon to exit from full screen display mode</p> <p data-bbox="308 1166 963 1241">When you switch to full screen in multiple-screen mode, Left click to toggle to only display one of the video in the multiple-screen mode or all.</p>
(17) Alarm Button	Click to trigger defined alarm(see also Chapter 5.9 Alarm Button)
(18) Alarm	Alert and display warning info. Only Administrator-level can reset and turn on, off and trigger the Sensor and Relay by right-clicking the item in the Sensor and Relay list.
(19) On Screen Keyboard	If the keyboard is not available, you may use the Virtual Keyboard.

4.3.1 Using Event Log Viewer



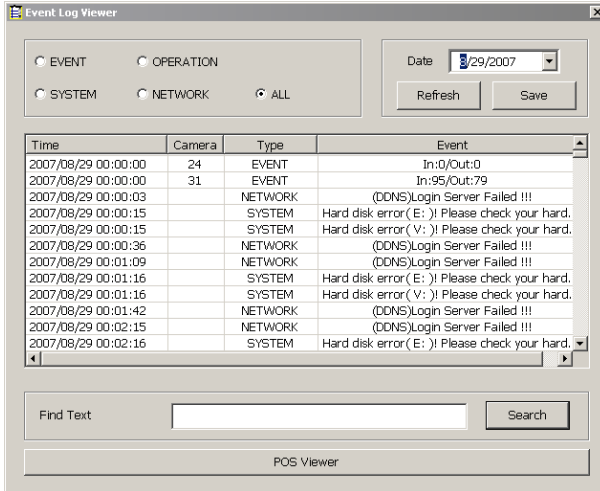

Show the record of activities that take place in the system.

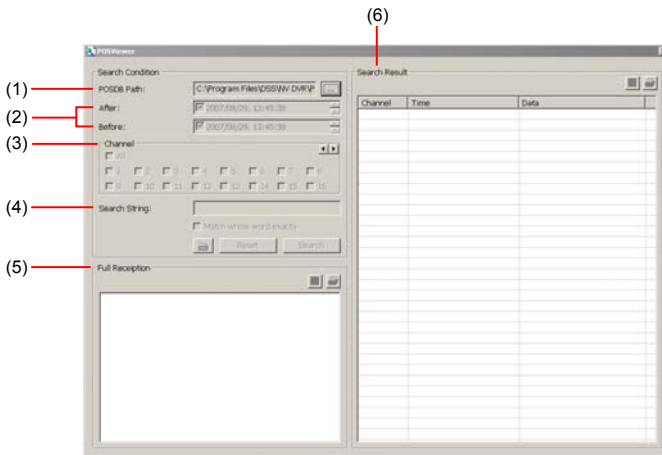

1. Click the Event Log button on DVR system main interface. The Event log viewer window will show up.
2. Select the Date to view or search certain event log by key word. Enter the key word in **Find Text** column and click **Search** button.
3. To filter the records, select and click the select button to display Event, System, Operation, Network or All.
4. The events list which display on the screen can be saved as text file format. To save the events list, click **Save** button.
5. To view POS event log, click **POS Viewer** bar to call out the POS event log window.



Name	Function
(1) POSDB Path	The storage path for POS event log. Click <input type="text"/> to change the storage path.
(2) Before/After	Set a time period before and after of POS event log.

Name	Function
(3) Channel	Select the POS event log of channel
(4) Search String	Enter specific key word or word string to search the POS event log. Mark the "Match whole word exactly" box if wants to find exactly key word or word string of POS event log.
(5) Full Reception	Display the POS event log detail that user selected from Search Result window. Click  to save the POS event log. Click  to print out the POS event log.
(6) Search Result	Display the POS event log of search result. Click  to save the search result. Click  to print out the search result.

4.4 Familiarizing the Buttons in Compact Mode

To view in Compact mode, click **Exit** button. In the logout dialog box, click **Compact**.

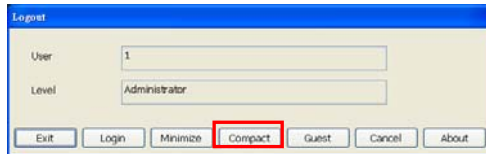

(1) (2) (3) (4) (5)

Name	Function
(1) Split Screen Mode	Select from 7 different split screen type to view all the camera, or one camera over the other or alongside on a single screen.
	<ul style="list-style-type: none"> - If there are only 4 cameras, you won't be able to switch to 9, 16, and 13 split screen mode. - When you are in single screen mode, Right click and Drag a square on the area you want to enlarge. - When you are in multiple-screen mode, Right click the video screen of the camera and Drag on where you want to locate it. To only display one of the video in the multiple-screen mode, Left click the video screen you want to display.
(2) AutoScan	Start/Stop video screen cycle switch

Name	Function
(3) Alarm	Alert and display warning info.
(4) Playback	Switch to Playback mode. This allows you to view the recorded video file. (see Chapter 4.5)
(5) Advanced	Switch to Preview/Advanced mode.

4.5 Familiarizing the Buttons in Playback Mode

To switch in Playback mode, click **Playback** button at the lower right corner of Advanced/Preview mode user interface.

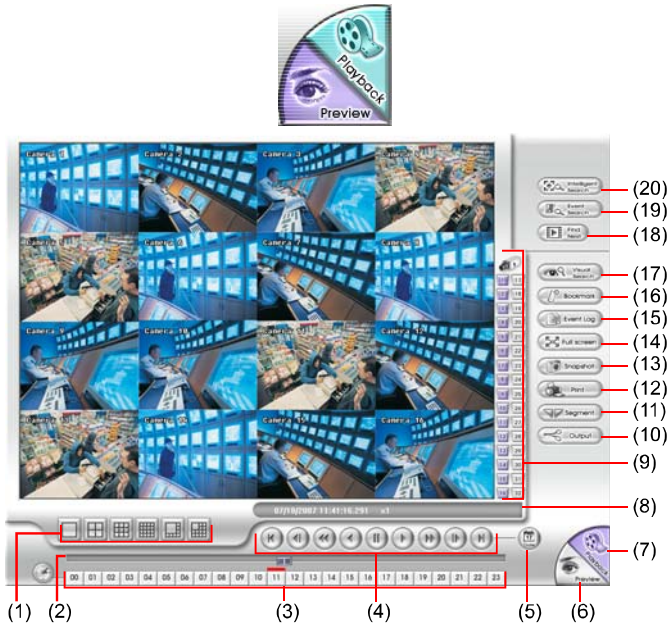

Name	Function
(1) Split Screen Mode	Select from 6 different split screen type to playback the recorded video file of all the camera, or one camera over the other or alongside on a single screen. To view 32 channels, click 16 split screen button to switch channel display.
i	<ul style="list-style-type: none"> - If there are only 4 cameras, you won't be able to switch to 9, 16, and 13 split screen mode. - To zoom in an area on the screen, Right click and Drag a square on the area you want to enlarge.
(2) Progress bar	Show the progress of the file being played. You may move the bar to seek at any location of the track.
(3) Hour Buttons	Select and click to playback the recorded video file on the specific time frame.
i	The Hour buttons represent the time in 24-hour clock. The blue bar on top of the hour button indicates that there is a recorded video file on that period of time. While the red bar indicates that you are currently viewing the recorded video file.

Name	Function
(4) Playback Control Buttons	<p>Begin: Move at the beginning of the recorded video file.</p> <p>Previous: Go back to the previous frame.</p> <p>Slower: Play the recorded video file at the speed of 1/2X, 1/4X, or 1/8X.</p> <p>Rewind: Wind back the recorded video file.</p> <p>Pause: Briefly stop playing the recorded video file.</p> <p>Play: Play the recorded video file.</p> <p>Faster: Play the recorded video file at the speed of 2x, 4x, 8x, 16x or 32x.</p> <p>Next: Go to the next frame.</p> <p>End: Go to the end of the recorded video file.</p>
(5) Date	Select the date on the calendar and the time from 00 to 23 to where to start playing the recorded video file.
<p>i The numbers from 00 to 23 represent the time in 24-hour clock. The numbers from 01 to 16 represent the camera ID. The blue colored column indicates that there is a recorded video file on that period of time. While the red colored column indicates on where to start playing the recorded video file.</p>	
(6) Preview	Switch to Preview/Advanced mode.
(7) Playback	Switch to Playback mode. This allows you to view the recorded video file.
(8) Status bar	Display the recorded date, time and play speed.
(9) Camera ID	Show the number of cameras that are being viewed. When you are in single screen mode, click the camera ID number to switch and view other camera.
(10) Output	Save the segmented file in *.mpg, *.avi, or *.dvr format (see also Chapter 4.8).
(11) Segment	Keep a portion of the recorded video (see also Chapter 4.8).
(12) Print	Print the screen shot.
(13) Snapshot	Capture and save the screen shot either in *.jpg or *.bmp format.
(14) Full screen	View in Playback-compact mode. To return, press the right button of the mouse or ESC on the keyboard or click the arrow icon.



Click the arrow icon to exit from full screen display mode

When you switch to full screen in multiple-screen mode, **Left** click to toggle to only display one of the video in the multiple-screen mode or all.



When there are dual monitors with 32 channels, the full screen mode will split into 16 channels on each monitor.

Name	Function
(15) Event log	Show the record of activities that take place in the system. To filter the records, select and click the option button to only display Event, System, Operation, Network or POS.
(16) Bookmark	Mark a reference point when previewing the recorded video file to which you may return for later reference. You may also set it to protect the file. (See also Chapter 4.9)
(17) Visual Search	Search from a specific camera by Date, Hour, Minute, 10 Seconds and Second. (See also Chapter 4.10)
(18) Find Next	Search for the next event or changes in the motion detector frame. You can use this when you are using Intelligent Search or Event Search function.
(19) Event Search	Search from the recorded activities that take place in the system (i.e., Sensor, Motion, Video Loss, POS) . (See also Chapter 4.11)
(20) Intelligent Search	Search the changes in the motion detector frame (See also Chapter 4.12).

4.6 Familiarizing the Buttons in PTZ Camera Controller

(see also [chapter 4.13](#))

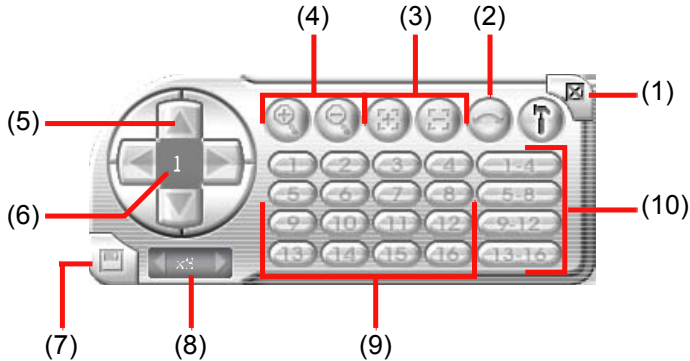

Name	Function
(1) Close	Exit PTZ camera controller.
(2) AutoPan	Operate the PTZ cameras automatically based on the selected camera group preset position number.
(3) Focus +/-	Adjust the focus manually to produce clear image.
(4) Zoom +/-	Zoom in and out the image.
(5) Direction buttons	Adjust and position the focal point of the PTZ camera.
(6) Camera ID pane	Display the PTZ camera number that is being operated.
(7) Save Camera preset position	Save the PTZ camera preset position number. Select the camera and click the preset position number and save it.
(8) Camera lens speed controller	Adjust the moving speed of the PTZ camera lens.
(9) Camera preset position number	Move the PTZ camera to the preset point.
(10) Group AutoPan	Select to automatically operate PTZ camera in group.

4.7 Setting Up and Using the Emap

E-Map can hold up to 8 maps in *.bmp/*.jpg format. You may locate the camera, sensor and relay on the map.

4.7.1 To Set Up the Emap

1. Click **Emap**.
2. When the Emap screen appears, click the area number (1 to 8 buttons) on where you want to insert the map.
3. Click **Load Map** to insert the map. When the open dialog box appears, locate and select the map and click **Open**.

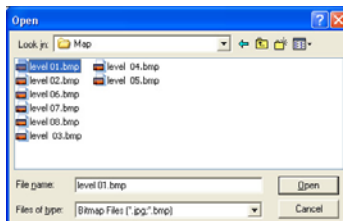

4. When the inserted map appears on the Emap screen, click **Edit**. You may now drag the camera, sensor, and relay icons to its place on the map. Icons on the map can be

relocated anywhere. Right click camera icon can select the camera direction in 8 angles. If you are going to locate the icon on the map to other area, you need to drag the icon to the black pane at the bottom of the Emap screen and then switch to the area on where you want to locate the icon.

To bring all the icons back to the black pane at the bottom of the Emap screen, click **Reset Icon**.



5. When you are done, click **Edit** button to save the new setting. To close Emap screen, click **Exit**.

4.7.2 To Use the Emap

To use the Emap:

1. Click **E-map**.
2. In the Emap screen, click the camera icon to switch on the area where the camera is located on the map and to display the video at the upper right corner of the Emap screen. At the lower right corner of the Emap screen, it lists all the warning message.



3. Click **Exit** to close Emap screen.

4.8 To Cut and Save the Wanted Portion of the Recorded Video

1. Use the Playback Control buttons or drag the bar on the playback progress bar and pause on where you want to start the cut. Then, click **Segment** to set the begin mark.



2. Use the Playback Control buttons or drag the bar on the playback progress bar and pause on where you want to end the cut. Then, click **Segment** to set the end mark. To cancel segmentation or set the segment marks from the start, click **Segment** button again.



3. Click **Output** button to save the wanted clip.
4. In the Save As dialog box, locate on where you want to save the file, type the filename, and select the video format.

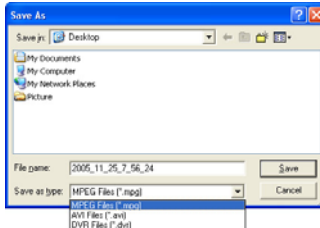

4.9 To Bookmark a Section of the Video

1. Click **Bookmark**. The video playback stops when the bookmark button is executed.
2. In the Bookmark dialog box, you may do the following:
 - **Add** to include the new reference mark in the bookmark list. You may select to enable/disable file protection.
 - **Edit** to change the mark description or enable/disable file protection.
 - **Delete** to remove the selected reference mark in the list.
 - **Delete All** to remove all the reference marks in the list.
 - **Exit** to close Bookmark dialog box.



When the bookmark is protected, the file won't be overwritten. The protected bookmark file will be deleted when the **Delete the recorded data** is enable in the **System setting**.(also refer to [5.1 System setting](#))

3. Select and click one in the bookmark list to preview the file.

4.10 To Search Using the Visual Search

1. Click **Visual Search**.
2. In the Visual Search Setting dialog box, select the Camera number and the date. Then click **OK**.

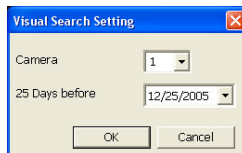

3. When a series of frames appear by date, click on the frame to display another series of frames and search by every Hour of that date, every 3Minutes of that hour, every 10 Seconds of that minute, every Second of that 10 seconds. To go back, click . To view from the selected frame and close event search, click .



4.11 To Search Using the Event Search

1. Click on the video screen on where you want to search.
2. Click **Event Search**. The Event Search text (red) would appear at the lower left corner of the screen.
3. In the Event Search Setting dialog box, check the type of condition you want to search. If you select POS, in the Find Text box, type the word. Then, click **OK** to start searching. The video search would stop at the frame that matches the condition. To keep on searching click **Find**.
4. You may also set to search and list all the result. Just check the **Output Event List** box. In the Search Duration section, set the **Begin Time**, **End Time** and **Searching Interval**. Then, click **OK** to start searching.
5. When the Event list appear, click and select the item you want to view.

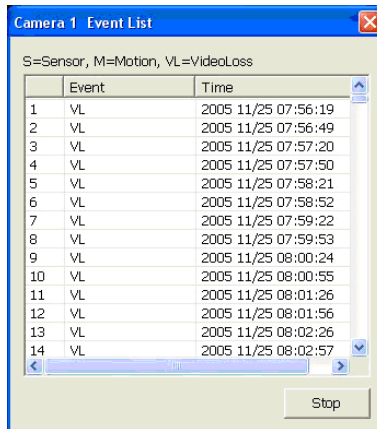

4.12 To Search Using the Intelligent Search

1. Click on the video screen on where you want to search.
2. Click **Intelligent Search**. The Intelligent Search text (red) would appear at the lower left corner of the screen.
3. When the Intelligent Search Setting dialog box and motion detector frame appear, you may adjust the sensitivity bar and the motion detector frame size and location. To set motion detector frame size and location, left click and drag on the screen. Then, click **OK** to start searching. The video search would stop at the frame that matches the condition. To keep on searching click **Find**.
You may also set to search and list all the result. Just check the **List** box. In the Search

Duration section, set the **Begin Time**, **End Time** and **Searching Interval**. Then, click **OK** to start searching.

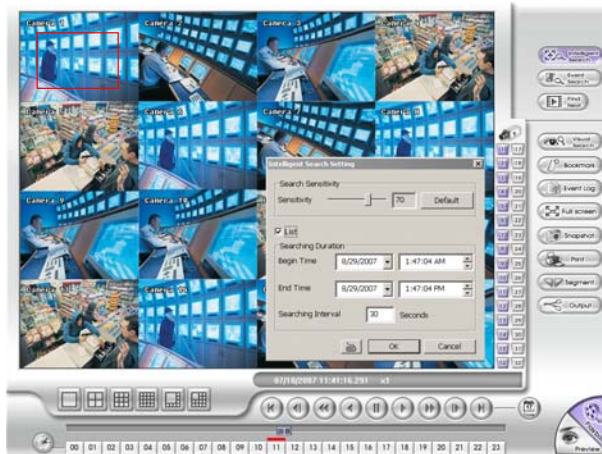

4.13 To Setup the IP PTZ Camera

1. In the PTZ control panel, click **Setup**.
2. Select the camera number and check the **Use PTZ** box.

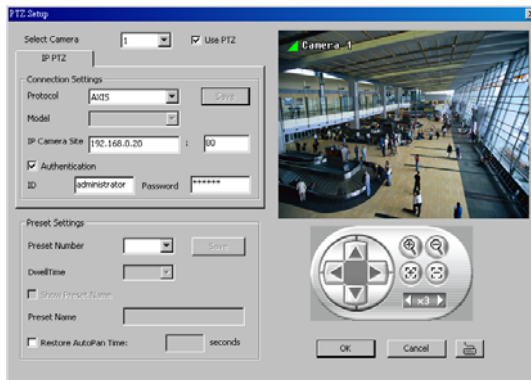

3. In the Connection Settings section, select the **Protocol** where the PTZ camera is connected and IP Camera Site that IP or URL of IP camera. Then, click **Save** to keep the settings.
4. Use the IP PTZ control panel and adjust the position of the IP PTZ camera.
5. In the **Preset Setting** section, select the preset number to assign a number for the IP PTZ camera current position. Set the **DwellTime** (1-60 sec) for how long the IP PTZ camera stays in that position before it moves to the next one. If you want to add description, check the **Show Preset Name** box and in the **Preset Name** text box, type the word. When done, click **Save** to keep the settings.
6. Repeat step 4 & 5, if you want to save another PTZ camera position.
7. **Restore AutoPan Time**: set a time period for restoring auto path function after the IP PTZ camera has been moved. Mark the check box and set the time period in second.
8. When is done, click **OK** to save the setting or Click **Cancel**, to leave without saving the new setting
9. The on screen PTZ controller is enabled when the IP PTZ camera is connecting to NX DVR system. User will see a small PTZ controller icon display on the right corner of

channel screen.



10. Click on screen PTZ controller icon to call out the control I panel.



- User can move the on screen PTZ controller to any position of screen
- The on screen PTZ controller only will display on one channel screen at a time.

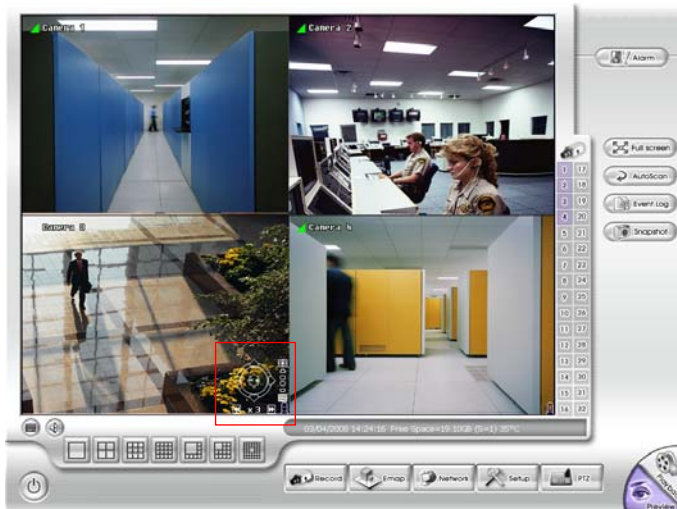

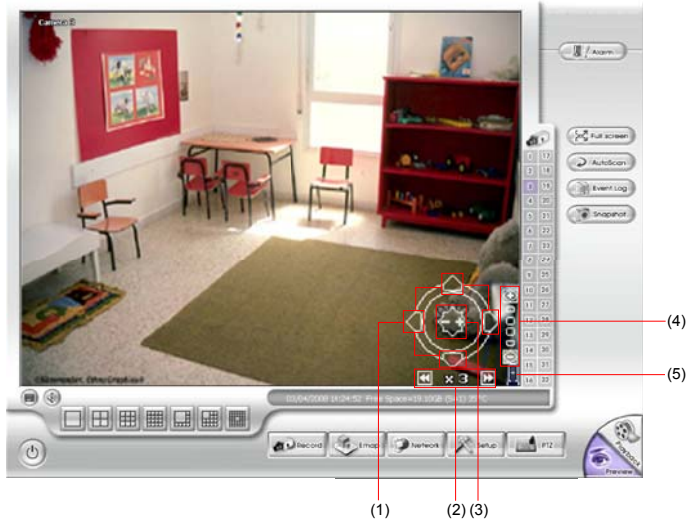

Name	Function
(1) Adjust arrow	To move the camera lens to up, down, left or right
(2) Speed up/down	To speed up or down movement of camera lens
(3) Focus +/-	Adjust the focus manually to produce clear image.
(4) Zoom +/-	Zoom in and out the image.
(5) On screen PTZ controller icon	To call out or close the on screen PTZ controller icon

Chapter 5 Customizing the DVR System

In the Preview/Advanced screen mode, click  button to customize your DVR. When the DVR configuration setup selection appears, select and click the buttons you want to change the setting.



5.1 System Setting

In the System Setting dialog box, click **OK** to accept the new settings, click **Cancel** to exit without saving, and click **Default** to revert back to original factory setting.

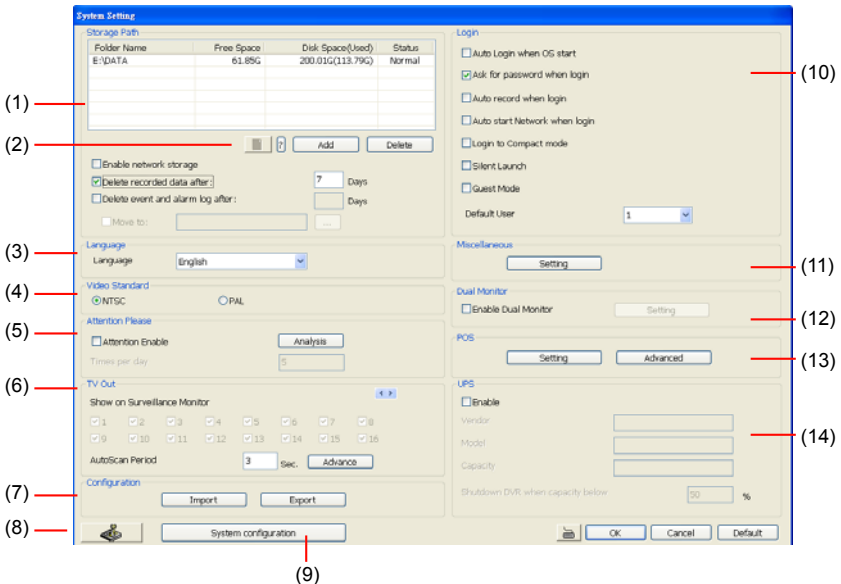

(1) Storage Path

Set the directory on where to save the data. When there is not enough free space to record one hour data, the system automatically replaces the oldest data. In case you have more than one storage path, the system automatically saves the data to the next storage path. You may also add additional network-attached storage (NAS) for extremely high storage capacity. Select the Enable network storage check box to send the recorded video in network-attached storage. To add network storage, the Internet storage drive/folder must be mapped as Network Driver in DVR server. Enable network storage first, and then, click Add. In **Browse For Folder** windows, select drive C and right click mouse button, select **Map Network Drive** option.

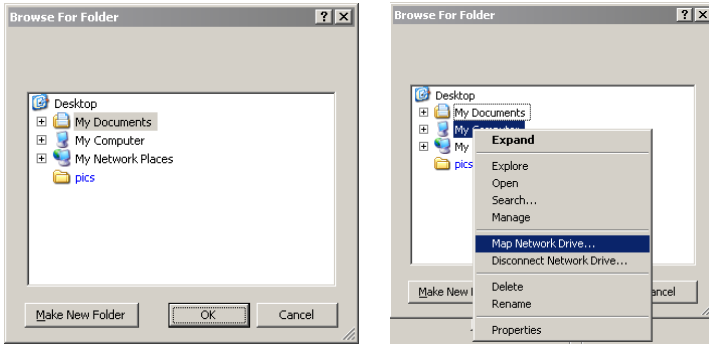

In the **Map Network Drive** windows, select the **Drive** and fill in the network drive direction in **Folder** column if you know. Or click **Browse** to find the folder direction. Click **Finish** to complete the network drive mapping. After the network drive has been added, user needs to create a folder for network storage. In **Browse For Folder** windows, select the network drive and right click mouse button to add a new folder. And then, click **OK**. User should see a new storage folder display in Storage path list.

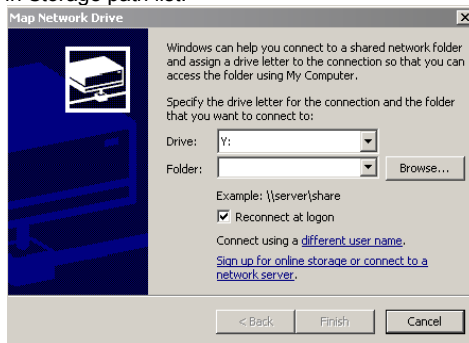

By default the data is stored in C:\Data, to insert another storage path, click **Add**. To remove the selected path, click **Delete**. If you want the system to automatically erase the data after a certain days, enable the **Delete recorded data after** check box and enter the numbers of days in **Days** text box. If you want the system to automatically erase the event and alarm log after a certain days, enable the **Delete event and alarm log after** check box and enter the numbers of days in **Days** text box. To change logs save direction, enable **Move to** and select the new save direction

(2) Hard Disk Calculator

Estimate the hard disk recording capacity. The result of calculation is a rough value which only for reference. The hard disk record capacity will be varied by the real record quality and complexity of video scene.

Click , the hard disk calculator windows will show up. **Total Recording time** is the current hard disk recording capacity. Enter the expect hard disk size or expect recording time in **Expected HD Size** or **Expected Record time**, and then click **Calculate** button. Click **OK** to exit the hard disk calculator windows. The hard disk calculation will base on the recording setup and current hard disk setup.

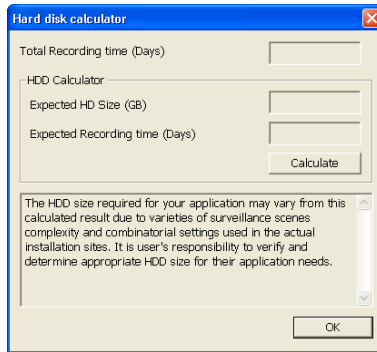

(3)Language

Customize the system to display the tool tips and dialogs based on the selected language. By default the language is in English.

(5) Attention Please

Check the attentiveness of the person who is monitoring the system. You may set the number of times the Attention dialog box to appear in a day in **Times per day** text box. To check the graph on how fast the person response, click **Analysis**.

When this feature is enabled, the Attention dialog box would appear. The person who is monitoring the system must enter the same number that appears from the left box at the right text box and then click **OK**.

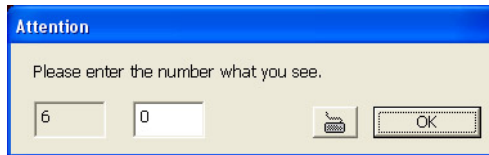

(6) TV Out

Select the camera you want to appear on TV and set the time gap from 3 to 10 sec. before it switches to the next camera.

- **Advance** button

Select the video card channel and camera that user wants to display on TV. Click **Advance** to enter configure interface.

☉ Autoscan

(1) The channel group display

(2) When the audio of IP camera is enabling, the channel of audio will be list in Audio drop down list

(2) Select the display mode as **Autoscan**.

(3) **Preview screen**: Live camera video would be displayed here.

(4) **Video Mode**: Select the video mode user wants to display on screen. The system will auto cycle switch to display the next channels.

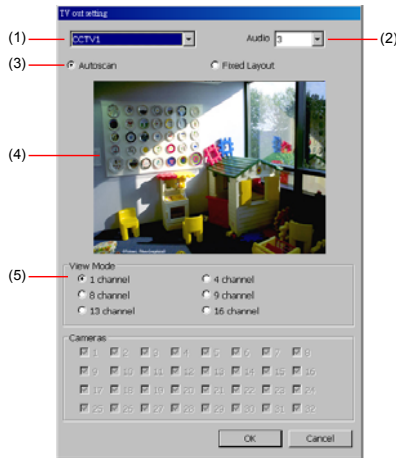

○ **Fixed Layout**

(1) The channel group display

(2) When the audio of IP camera is enabling, the channel of audio will be list in Audio drop down list

(3) Select the display mode as **FixedLayout**.

(3) **Preview screen:** the selected camera video will preview in here.

(4) **Video Mode:** Select the split mode of TV out display.

(5) **Cameras:** User can select the cameras that user wants to display on the screen. Only those selected channels would be displayed on the screen. Also, the camera will be displayed by the selecting order.

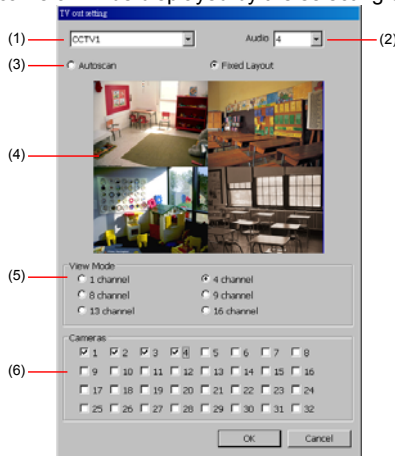

(7) Configuration

Backup a copy of all the settings and allows you to regain the same settings back. To save the current settings, click **Export**. To replace the settings with the one you have saved, click **Import**.

(8) System Controller Setup

To configure the parameters that is for communicating with the System Controller (an optional accessory). Also please refer to user manual of the System Controller.

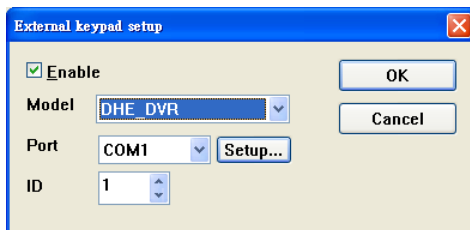

Enable – Mark the check box to enable the System Controller function.

Model – Select model of the System Controller.

Port – Select the com port that is connected with the System Controller. Click **Setup** to configure com port value. The com port value is shown in below table:

Baud rate	9600
Data bits	8
Parity	No
Stop bit	1
Flow control	No

ID – Set an ID for DVR server (0~99). This ID is a key for communicating between the System Controller and the DVR server.

i When the DVR server ID is X, the DVR server can be controlled by System Controller irrespective of the DVR ID that is selected in System Controller.

(9) System Configuration

To configure the DVR system date, time and IP address.

Date/Time Setup

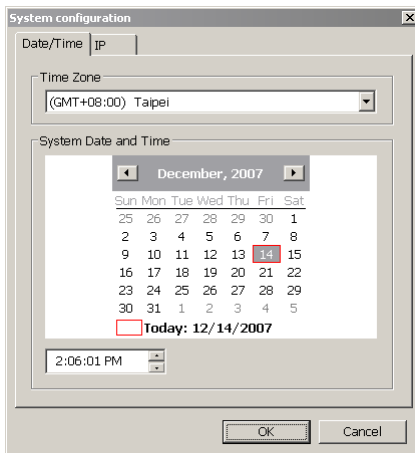

1. Select the **Time Zone** of DVR server located
2. Select the **Month** and **Date**. Click arrow button can switch to different month.
3. Adjust the **Time** by click spin box arrow button.
4. Click **OK** to save the configuration.

IP Setup

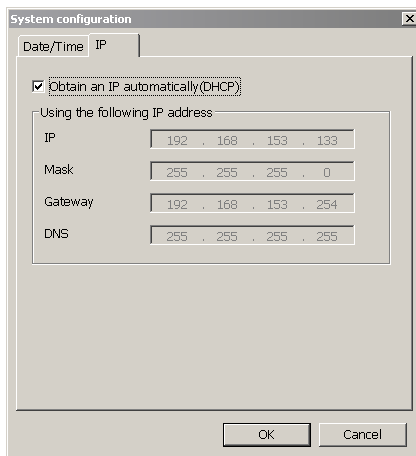

Obtain an IP automatically (DHCP): To use DHCP server assigning DVR server a IP address.

Using the following IP address: Assign a fixed IP address for DVR server

- **IP ADDRESS:** Assign a constant IP address which a real IP addresses give from ISP to DVR system.



Do Not assign the DVR to 1.0.0.0 network segment. It will ca use the DVR can not access to Internet due to the un-recognize to 1.0.0.0 IP segment.

- **Mask:** It is a bitmask used to identify the sub network and how many bits provide room for host addresses. Enter the subnet mask of the IP address which user has assigned to DVR system.
- **GATEWAY:** A network device act as a passageway to internet. Enter the network gateway IP address
- **DNS:** Domain Name Server translates domain names (such as www.abb.com.tw) to IP addresses. Enter the IP address of DNS if it is available.

(10) Login

Enable the conditions in Login section you want the system to automatically carry out.

- **Auto Login when OS start**
Execute the NV DVR when the operating system is started.
- **Ask for password when login**
Request to enter User ID and Password each time the NV DVR is executed.
- **Auto record when login**
Automatically start video recording when the NV DVR is executed.
- **Login to compact mode**
Switch to compact mode directly when the NV DVR is executed.
- **Silent Launch**
Enable the DVR system minimizes on the system tray automatically right after start up.
- **Guest Mode**
Automatically log in Guest mode when the NV DVR is executed. In guest mode, the functions are limited to preview and playback only.
- **Default user**
Automatically log in to the selected default user when the NV DVR is executed.

(11) Miscellaneous

Enable the conditions in **Miscellaneous** section you want the system to perform.

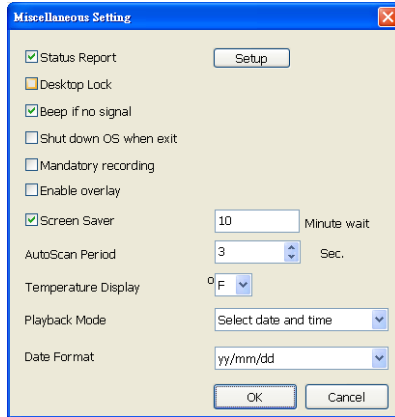

- **Status Report**
Send a daily system event and attention analysis report. To change the e-mail settings, click **Setup**.
- **Desktop Lock**
Deactivate the [Ctrl-Alt-Del] and [Windows] keyboard key functions.
- **Beep if no signal**
Make sound when the video signal is lost.
- **Shutdown OS when exit**
Turn off the PC when the NV DVR application is being closed.
- **Mandatory Record**
Always record video when software is running
- **Enable Overlay**
To enhance video signal for better video quality.



Only support on NV6000 (Exp) and NV7000H card.

- **Auto Scan Period**
Set the time gap of the Auto Scan function from 3 to 10 seconds. This automatically switches to the next video in cycle depending on the set time gap.
- **Temperature Display**
Select the format of temperature -- °C or °F
- **Playback Mode**
Select the mode of playback the video.
Select date and time: Select the date and time which user wants to playback.
Play the last file: Automatically playback the video from the last hour
Instant Playback: Automatically playback the video which has just recorded
- **Date Format**
Select the date format which wants to display in **Select date and time** playback mode

(12) POS

Set from which camera screen to display the data from the POS equipment. Click **Setting**, to set the POS Console Setting. To set the text flow and color format, click **Advanced**. (see also [Chapter 5.1.1](#))

(13) Dual Monitor

Enable/disable dual monitor display. Click **Setting** to select the dual monitor display mode.

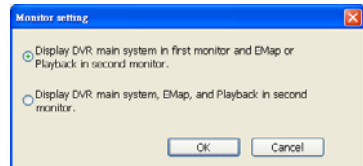

(14) UPS (Uninterruptible Power Supply)

Protect the system from damaging, such as power surges or brownouts. This automatically gives time to close the DVR properly when the battery backup power has reached the Shutdown when capacity below percentage level setting.

The UPS device must be connected to your computer (refer to your UPS user's guide)



The UPS application must meet Windows 2000 or Windows XP system requirements.

5.1.1 To Set the POS Setting:

1. In the System Setting dialog box, POS section, click **Setting**. To set the text flow and color format, click **Advance**.
2. In the POS Console Setting dialog box, click **Add** to set a new POS setting, **Modify** to change the POS setting, and **Delete** to remove the selected POS setting. Click **OK** to save and close POS Console Setting.

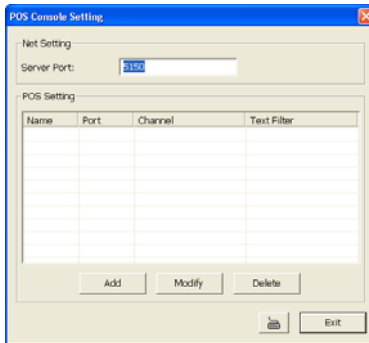

3. In the POS Mapping dialog box, click **OK** to accept the settings and **Cancel** to exit without saving the new setting.

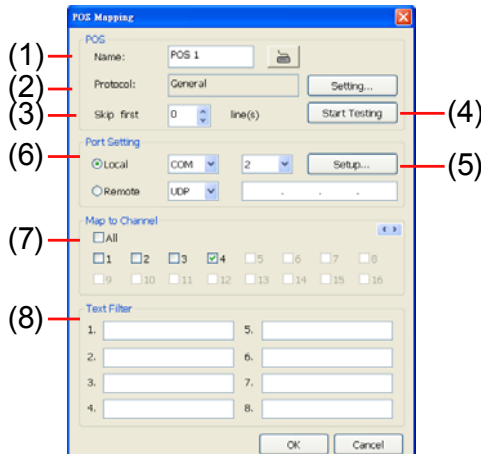

- (1) **POS Name** : Enter a name to identify the POS.
- (2) **Protocol** : To select the protocol, click **Setting** button (see Setup POS Protocol)
- (3) **Skip first** : Set the number of lines you want to be removed
- (4) **Start Testing** : Click to test POS setting. You will see a test result on the right side of POS Mapping window.

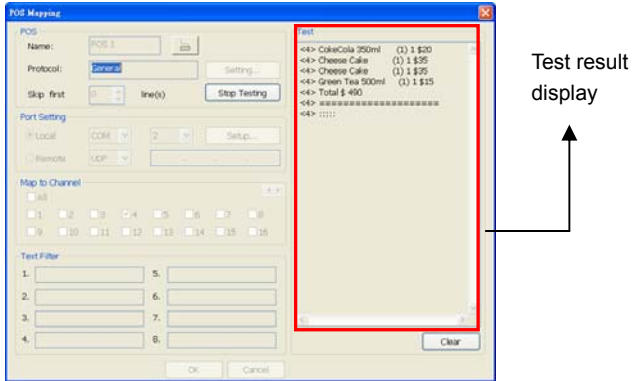

- (5) Setup... : Set the COM Properties. If you are not sure, please contact your POS service provider.

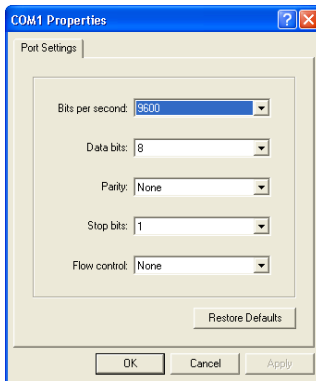

- (6) Port Setting : Select the Local or Remote port to where it is connected.
Local - select the COM port number which is connected.

Remote – Use the UDP protocol for remote connection if POS system can broadcast to Internet. Enter the IP address of the remote station.

- (7) Map to Channel : Select to which camera number to display the transaction text.
 (8) Text Filter : Enter the word you want to be removed.

Setup POS Device

There are 4 default POS devices. If user uses the POS device beside defaults, user can add new POS device and rules. The POS device can be added up to 50 include defaults.

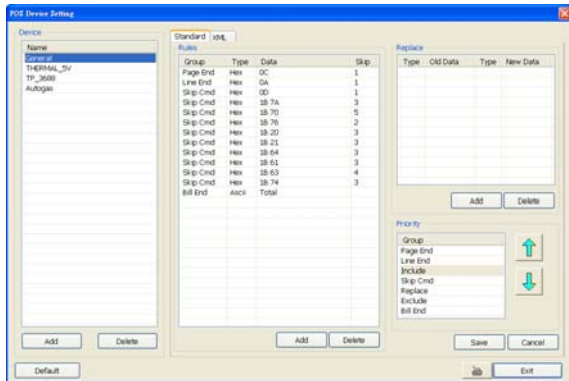

Setup Standard POS Device

● Add New POS Device

1. Click **Add**
2. Enter the POS device name in **Name** column
3. Select the **Type** as **Standard**
4. Click **OK** to save
5. To modify existing device, double click it.
6. Click **Default** can be reset back to original setting.



● Add Rules

1. Select the POS device form device list
2. Click **Add** in Rules section
3. In Rule Setting windows, select **Group**. Each group has a limited number of times ; please refer to the **"Maximum"** and **"Remainder"** information in Rule Setting windows. The Line End, Page End, and Bill End group only can be set once.
 - **Line End**: set a rule to separate each line.
 - **Page End**: set a rule to switch page.
 - **Skip Cmd**: set a rule to discard a string or character.
 - **Include**: set a rule for a lime with a string or character to be displayed.
 - **Exclude**: set a rule for a line with a string or character to be concealed.
 - **Bill End**: set a rule to divide each transaction.
4. Select **Type** – Ascii or XML
5. Enter the string or character as the rule in **Data** column. The maximum length is 31 characters.

6. Click **OK**
7. Click **Save**. The configuration will be lost without saving.
8. To modify existing replace rules, double click it.

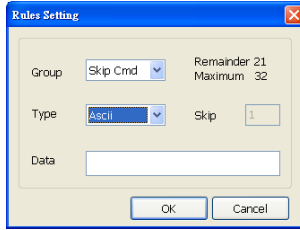

● **Character Replacement**

Set a rule to replace a character or word in POS data. The maximum replacement is 8.

1. Select a POS device from device list
2. Click **Add** in Replace section
3. **Old Data:** select the **Type**(Ascii or Hex) and enter word or character that wants to be replaced
4. **New Data:** select the **Type** (Ascii or Hex) and enter the word or character that will replace it in Old Data.
5. Click **OK**
6. Click **Save**. The configuration will be lost without saving.
7. To modify existing replace rules, double click it.

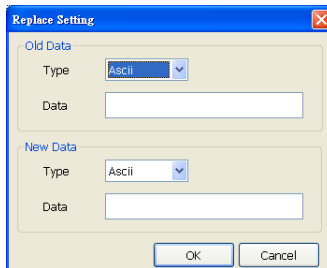

● **Adjust Rule Priority**

User can set the priority of rule groups. Select the group and click up/down arrow button to move the priority level. The upper position, the priority is higher.

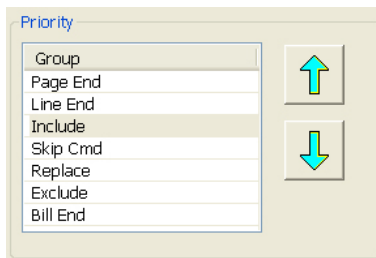

Setup XML POS Device

XML can only work with the POS data is transmitting in XML format.

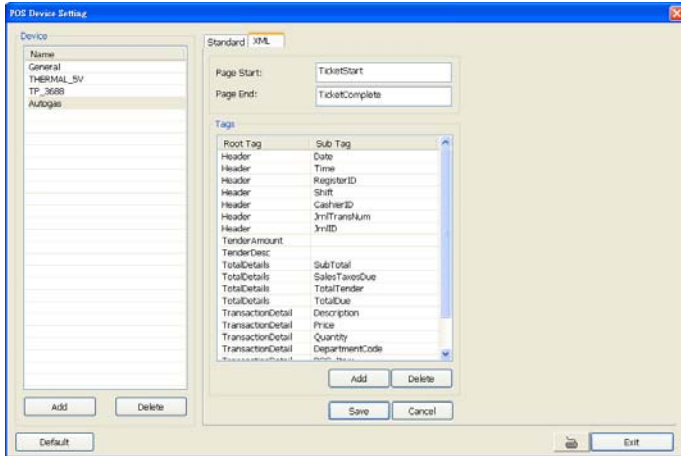

- ✓ **Device:** select or add a new device. Only device that supports XML can be configured in here. Click **Add** to add a device. Enter device name and select Type as **XML**. The POS device can be added up to 50 include defaults.

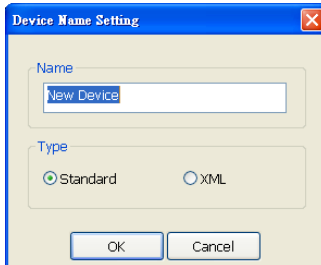

Page Start: Beginning of data for transaction

Page End: End of data for transaction

Tag: select a root tag and sub tag as a range for data transaction to DVR server. Click **Add** to set a tag. Click **Save**. The configuration will be lost without saving.

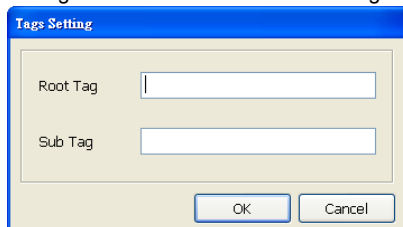

Please refer to the following example for more detail.

<TicketStart> → **Page Start**

<Header> → **Root tag**

```

<MessageVersion>1.0</MessageVersion>
<Date>20060317</Date>
<Time>164216</Time>
<RegisterID>3</RegisterID>
<Shift>4</Shift>
<CashierID>000000009</CashierID>
<JrnTransNum>3</JrnTransNum>
<JrnIID>0</JrnIID>

```

→ **Sub tag**

</Header>

</TicketStart>

<Item>

<SaleTotals>

<Item>

<SaleTotals>

<Item>

<SaleTotals>

<TenderEvent>

<TicketComplete> → **Page End**

The screenshot shows a software interface with two tabs: 'Standard' and 'XML'. The 'XML' tab is active. It contains two input fields: 'Page Start:' with the value 'TicketStart' and 'Page End:' with the value 'TicketComplete'. Below these is a 'Tags' section containing a table with two columns: 'Root Tag' and 'Sub Tag'. The table lists various XML tags and their corresponding sub-tags. At the bottom of the interface are 'Add' and 'Delete' buttons.

Root Tag	Sub Tag
Header	Date
Header	Time
Header	RegisterID
Header	Shift
Header	CashierID
Header	JrnTransNum
Header	JrnIID
TenderAmount	
TenderDesc	
TotalDetails	SubTotal
TotalDetails	SalesTaxesDue
TotalDetails	TotalTender
TotalDetails	TotalDue
TransactionDetail	Description
TransactionDetail	Price
TransactionDetail	Quantity
TransactionDetail	DepartmentCode
TransactionDetail	POS Item

5.2 Camera Setting

In the Camera Setting dialog box, click OK to accept the new settings, click Cancel to exit without saving, and click **Default** to revert back to original factory setting.

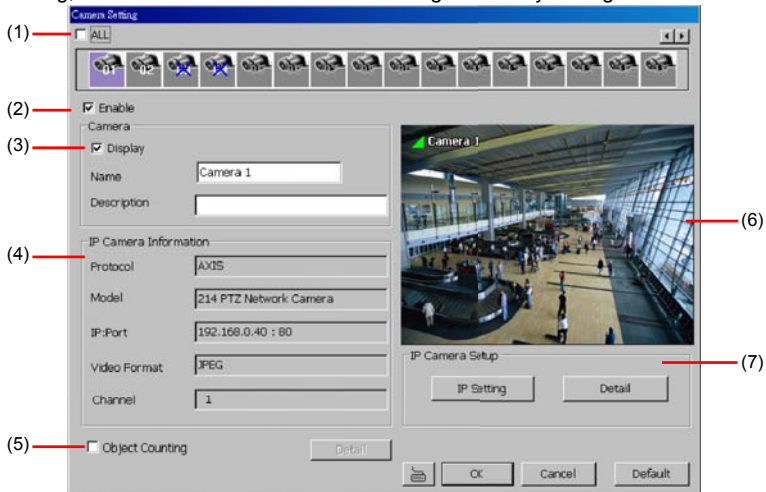

(1) Camera Icons

Select the camera number you want to adjust the video setting. To select all the cameras, enable the **ALL** check box. To select more than one camera, **Right click** on the camera icon. To select one camera only, **Left click** on the camera icon. The camera icon turns red when it is selected.

(2) Enable

Set to enable/disable the selected camera. When there is no video source on the camera, we suggest disabling it so that the system won't detect it as video loss error.

(3) Camera

- Display

Enable/disable to show the video. Even if the video of the selected camera is hidden you can still record the video and preview it in playback mode.

- Name

Change the camera name.

- Description

Add a short comment.

(4) IP Camera Information

Click the camera icon to display the connected IP camera information in here.

(5) Object Counting

Select the two regions on the screen and the system will count the objects that appear from one selected region to another selected region. (See also [5.2.1](#)).

(6) Video Screen

Display the video of the selected camera.

(7) IP Camera Setup

The video source is coming from Network camera.

- **IP Setting:** click **IP Setting** to enter the IP Camera Settings windows. In the IP Camera Settings dialog box, select to connect using Protocol or URL and then enter the required info. User also can click **Search Device** to find the selected protocol of

camera on the LAN network. If user is not sure the camera is which model, click **Detect Model** to find the correct model of camera. If it requires user identification, enable **Authentication** check box and enter User ID and Password. To enable audio, click **Enable Audio** check box. If you are not sure of the Protocol or URL info, please refer to the IP camera manual or contact your IP camera local distributor.

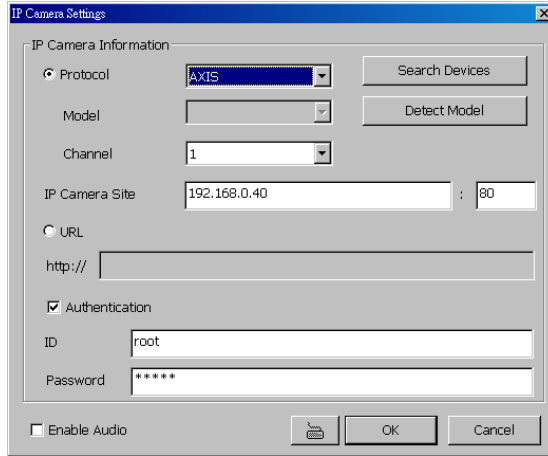

- In Camera Setting interface, click **Detail** to configure **Video**, **Senor**, **Relay**, and **Direct Link by IE** of the IP camera.

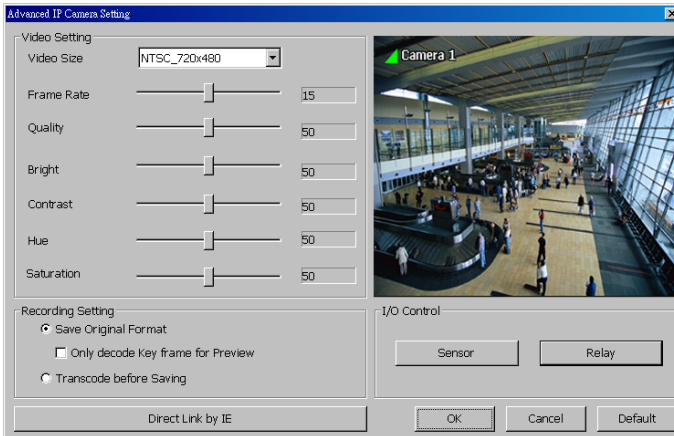

- **Video Setting**

Select the video size and adjust the Frame Rate, Quality, Bright, Contrast, Hue, and Saturation of the selected camera.

- **Recording Setting**

- **Save Original Format:** Save the video that is compressed by IP camera's compress mode.
 - ✓ **Only decode key frame for Preview:** When selected the **Save Original Format** selection, user can mark **Only decode key frame for Preview** this option. When previewing video, DVR system only shows key frame and one frame per second.
- **Transcode by MPEG4 Encoder:** Decoding the video and compress video again by using MPEG4 encoder.

- **Direct Link by IE**

Using IE browser to connect to camera and view the real time video. Click **Direct Link by IE** , the IE browser will pop up and connect to camera. The video viewing interface will be varied by different brand of camera.

- **I/O Control**

⊙ **Sensor Setting**

To setup sensor that is embedded on the camera.

1. Click the drop-down list and select the sensor ID number.
2. Enter sensor name in **Name** column
3. The system automatically detects the camera and input relates information. In the Content section, enter sensor description.
4. In the test section, click **Test** to check the sensor status. Red is high and Green is low.
5. Click **OK** to exit and accept the setting and **Cancel** to exit without saving the setting.

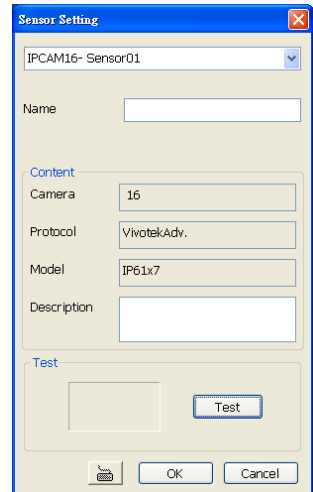

⊙ **Relay Setting**

To setup relay device that is embedded on the camera.

1. Click the drop-down list and select the relay ID number.
2. Enter relay name in **Name** column
3. The DVR system automatically detects the camera and input relates information. In the Content section, enter relay description.
4. In the test section, click **Test** to trigger relay. Red is high and Green is low.
5. Click **OK** to exit and accept the setting and **Cancel** to exit without saving the setting.

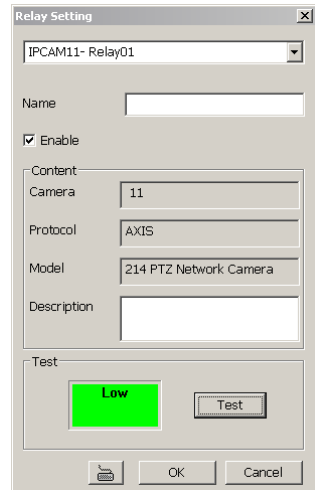

5.2.1 Setup the Object Counting

1. Click **Detail** to enter the object counting setup window.



2. Enable **Detected Regions** in **Display** section. This enables the object counting information show on the screen. **Moving Object** will enable the object size frame to show on the screen.
3. Click **Region1** and press left button of mouse and drag the area that user wants the object to be counted. And then, click **Region2** and drag another area that user wants the object to be counted, too. Those selected regions will mark in different color. The system will count the objects that move between the selected regions.
4. Click **Object size** to define the detected object dimensions. Press left button of mouse and drag on the screen. To see the object size frame on screen, enable **Moving Object** in Display section.
5. Adjust the sensitive of object detecting.
6. To test the setting, mark the **Directions (In/Out)** want to be test and click **Start**. The testing result will show in Test section.
7. Click **OK** to save the setting. Click **Cancel** to leave the setup window without saving.
8. The object counting information will be display on the screen of upper part.

Object counting information display

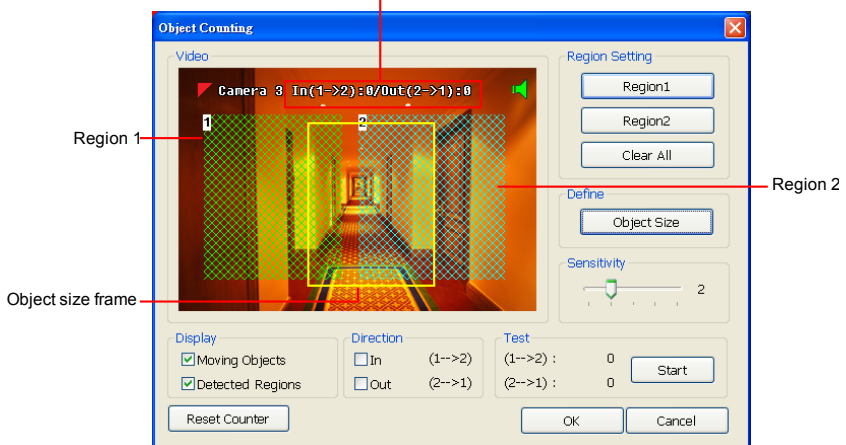

5.3 Recording Setting

In the Recording dialog box, click **OK** to accept the new settings, click **Cancel** to exit without saving, and click **Default** to revert back to original factory setting.



The gray selections are not support for IP camera.

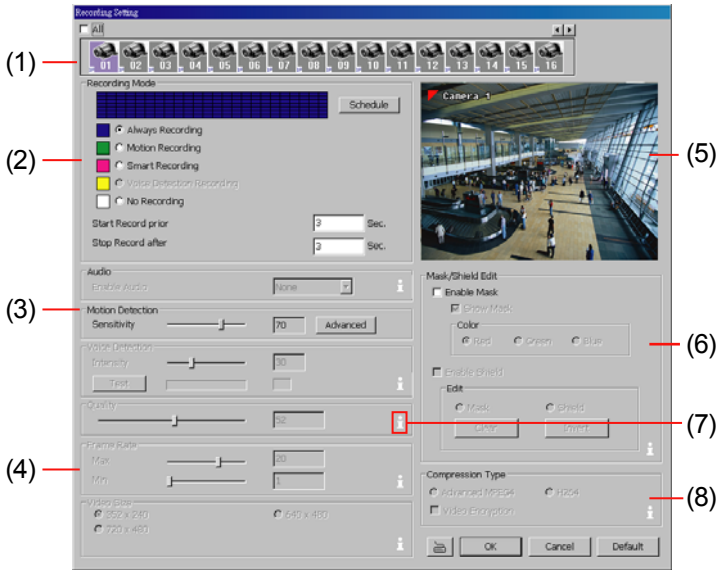

(1) Camera Icons

Select the camera number you want to set the recording setting. To select all the cameras, enable the **ALL** check box. To select more than one camera, **Right click** on the camera icon. To select one camera only, **Left click** on the camera icon. The camera icon turns red when it is selected.

(2) Recording Mode

The blocks from 00 to 23 represent the time in 24-hour clock. To record in full 24 hours, select the recording mode and click the button. If you want to only record at a particular time, click the colored block beside the recording mode then click on the time blocks. When the system starts recording a red triangle mark would appear at the upper left corner of the screen. The recording modes are listed below:

- Always Recording

Record the video from the selected camera and save it to the designated storage path (see also [Chapter 5.1 #1](#)).

- Motion Recording

Start recording the video from the selected camera only when the system detects movement. Once a motion is detected, the system automatically saves the previous frames and stop based on the **Start Record Prior** and **Stop Record After** settings.

- Smart Recording

Automatically switch to recorded at the maximum frame rate setting once a motion is detected and if there is no motion, it records at the minimum frame rate setting. Set the maximum frame rate setting in [\(5\) Frame Rate](#).

- No Recording

The system won't do any recording.

(3) Motion Detection

Adjust the sensitivity of the motion detector. The higher the value, the finer the sensitivity is

detected. When it detects a motion, a green triangle mark would appear at the upper left corner of the screen.

(4) Frame Rate

Set the maximum number of frames to be recorded during motion and motionless state. The frame rate ranges from 1 to 30 for NTSC and 1 to 25 for PAL. The higher the frame rate, it uses more hard disk space.



Only available when user selected "**Transcode by MPEG4 Encoder**" in **Video Setting at Camera setting** section(see [Chapter 3.2 #9](#))

(5) Video Screen

Display the video of the selected camera

(6) Mask/Shield Edit

Mask, mark an area on the screen to disregards the motion in the marked area and to only monitor outside the marked area. As for the Shield, it covers an area on the screen and the covered area would not be visible on the screen and recorded. (see also [Chapter 5.3.1](#) and [5.3.2](#))

(7) Information Prompt

Move the mouse to "i" icon for information prompting.

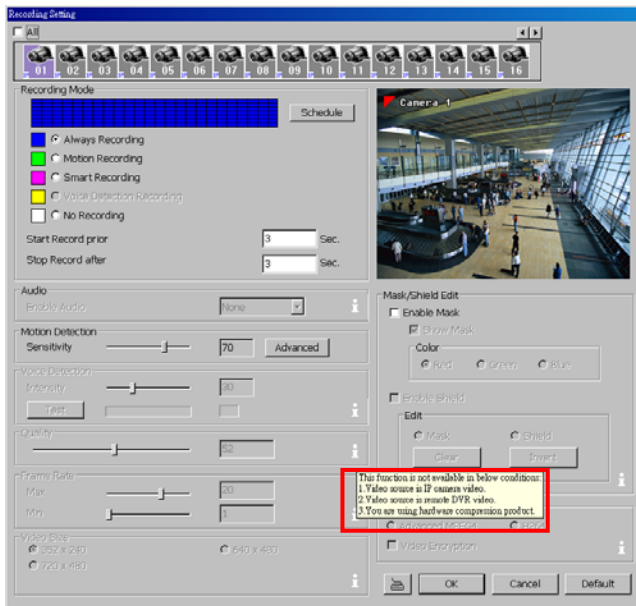

(8) Compression Type

Select from 3 compression types. User can refer the table below to check the NX card supports what type of compression. H264 is the latest and advanced video compression format that delivers better video quality and smaller file size but this uses more CPU resource. Advanced MPEG4 and MJPEG, both provide a standard for color picture compression rate. MPEG4 uses higher compression rate and smaller file size. While MJPEG uses slightly lower compression rate and bigger file size.

Using the Advanced MPEG4 enables you to encrypt the recorded video that way only the person who knows the password can clearly view the video playback. The file size



would become 10 to 30% more. Enabling the Video Encryption check box, you will be prompted to enter the password and retype the password for confirmation. Make sure not to forget the password for you would not be able to decrypt the video without it.

The  symbol would appear on the upper right corner of the encrypted video screen. You may see the video during live recording (see also [Chapter 5.3.3](#)).



Only available when user selected "**Transcode by MPEG4 Encoder**" in **Video Setting** at **Camera setting** section(see [Chapter 3.2 #9](#))



5.3.1 To Mask/Shield an area on the screen:

1. In the Mask/Shield Edit section, activate the **Enable Mask/Enable Shield** check box.
2. In the Edit section, select between Mask or Shield and click the  button.
3. Click and drag a frame on the **(7) Video Screen** to create Mask or Shield area.



Only available when user selected "**Transcode by MPEG4 Encoder**" in **Video Setting** at **Camera setting** section(see [Chapter 3.2 #9](#))

5.3.2 To show and change the color of the Mask:

1. Enable the **Show Mask** check box.
2. In the Color section, select the color and click  button.

5.3.3 To Playback Encrypted Video:

On Playback, Webcam, and Remote Console video screen, just click  and enter the correct password to decrypt and playback the video.

To encrypt the recorded video back, click  and enter a **WRONG** password.



It is important to encrypt the video again, to avoid unauthorized user viewing the video.

5.4 Network Setting

In the Network Setting dialog box, click **OK** to accept the new settings, click **Cancel** to exit without saving, and click **Default** to revert back to original factory setting. For the network service ports that use by DVR server, please see [Appendix C](#).

The screenshot shows the 'Network Setting' dialog box with the following sections and callouts:

- (1) Server Name: A text input field.
- (2) Transmitting Cameras: A section with a grid of checkboxes for cameras 1 through 16, and an 'ALL' checkbox.
- (3) Main Configuration: Fields for Server IP (192.168.153.60) and Remote Console PORT (5550).
- (4) Dynamic DNS: Fields for Domain Name, Password, DDNS Server Name (ddns.avers.com.tw), and DDNS Server Port (1053).
- (5) Remote Control Server: Fields for Enable (checked) and PORT (5555).
- (6) Network Video Configuration: Sliders for Quality Level and Frame Rate Level, both set to 3.
- (7) WebViewer Configuration: Fields for WebViewer PORT (80) and a button for 'Update WebViewer Digital Signature'.
- (8) Voice Phone: Fields for Talk to Web-Client (checked) and PORT (9999).
- (9) Network Time Synchronization: Fields for Time Server and a button for 'Synchronize Time Right Now'.
- (10) Other Configuration: Fields for UPnP, Enable Original Security Protocol, Enable White List, Enable HandyViewer, and Network Bandwidth Limit.

(1) Server Name

Assign a name for the DVR unit. Alphabet letters and numbers only.

(2) Transmitting Cameras

Select and click on the camera number in the Transmitting Camera section you want to make it accessible via internet using WebViewer, Remote Console, PDA Viewer and Hand Viewer (still image). To select all the cameras, enable the **ALL** check box.

(3) Main Configuration

Set the Server IP and Remote Console Port number. The system will automatically detect your Server IP address. You need this when accessing DVR server from the remote location via internet.

(4) Dynamic DNS (Domain Name System)

Enter the Domain Name and Password. To use this feature, go to <http://ddns.avers.com.tw> and register. (also see [Appendix A](#)) You will be prompted to enter CD key number, product name, password, and user information. Use this service if the IP address changes each time when you connect to internet.

(5) Remote Control Server

Enable/disable remote control from remote application (ex. CM3000). Enter the remote accessing port in **Port** column. The default value is 5555.



User also can manually run this function. To run, click **Start > Programs > DSS > Tool > Remote Control Server**. The remote control server icon appears on the taskbar when the remote control server is enabled. (also see [Chapter 12](#))

(6) Network Video Configuration

Set up the video quality and frame rate for viewing and transmitting to the remote program. Scrolling adjust bar to set the **Quality level** and **FrameRate level**.

(7) WebViewer Configuration

Activate **Enable Anonymous Login** to remotely access the DVR server without the need of password

(8) Voice Phone

The **Talk to Web-Client** is to use the 2-Way Talk feature that allows the client and server to talk via internet using microphone. Make sure both microphone and speakers work before using this feature. If the **Talk to Web-Client** is disabled, the person in the DVR server side can only hear the voice from the client side that is when the WebCam 2-Way Talk button is activated. (see also [Chapter 8.1 #6](#)).



Make sure that your Webcam Digital Signature is updated yearly; else you won't be able to access the DVR server from the DVR WebViewer. To update/download your WebViewer Digital Signature, click **Update WebViewer Digital Signature**. Make sure your PC is connected to internet.

(9) Network Time Synchronization

Adjust the DVR system time same as network time server. Fill in the **Time Server IP** address or domain name. Select **Automatic Synchronize** time to set automatic synchronize time on a daily basis. Or, user can click **Synchronize Time Right Now** to adjust time right away.

(10) Other Configuration

- UPnP

Enable UPnP function to automatically configure the port setting on the local network. This function is available when there is UPNP device in the same network. It will write the DVR port information into the router or other network device (see Appendix B)

- Enable White List

An access permit list for the remote accessing of DVR server. Enter the IP address and click **Add**. Or, enter a range of IP address and click **Add**. To delete the IP from the list, select the IP and click **Delete** button. To reset the input, click **Clear** button.

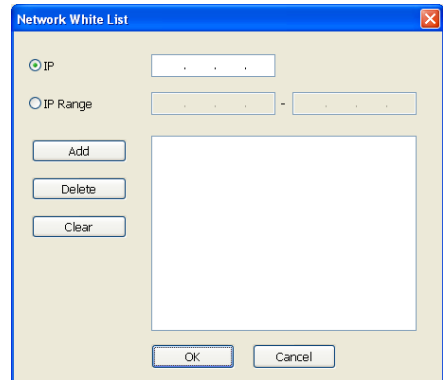

- Enable HandyViewer

Enable remote users to use a PDA or a mobile phone to access DVR server and select the video size and quality. (See also [Chapter 8.5 and 8.6](#))

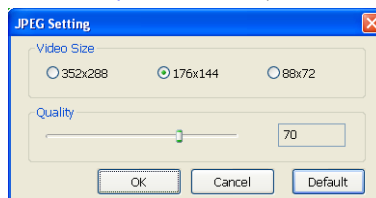

- Network Bandwidth Limit

By Channel: Set the network bandwidth by each channel.

All: Set the total network bandwidth consumption limit.

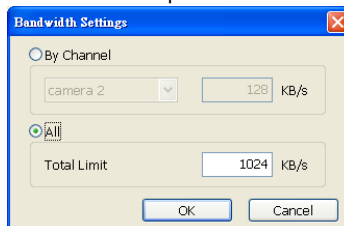

5.5 Schedule Setting

Schedule to record, backup, enable network, reboot and disable alarm of all the cameras either weekly or one time. The number from 00 to 23 represent the time in 24-hour clock. The left most column display the days in a week.

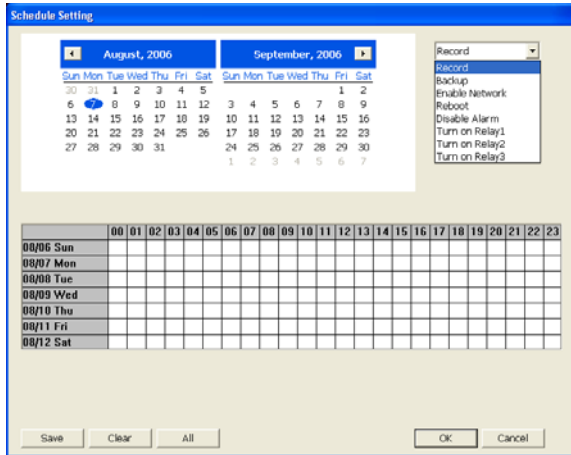

To Set the Schedule Setting:

1. Select the date in the calendar. Use and buttons to shift the calendar to the left or right.
2. Select the condition you want to schedule in the drop down list.

- **Record**

Activate all the cameras to start video recording at the set time based on the Recording setting (see also [Chapter 5.3](#)).

- **Backup**

Save another copy of all the data at the set time and specified backup path. DVR automatically updates and only backup the data that are not yet included in the archive. To assign backup path, click .



Make sure the backup folder and storage folder are not on the same drive.

- **Enable Network**

Activate DVR remote system to access at the set time. After the appointed time, the Network function will be disabled. If the Network function is already enabled, the Network function will not be disabled when the appointed time has ended.

- **Reboot**

Restart the PC at the appointed time.



Make sure the Windows operating system is set **NOT** to require you to login user name and password. This way the system will be able to run DVR program.

- **Disable Alarm**

Deactivate the alarm at the set time temporarily.

- **Turn on Relay #**

Active the Relay at the set time. If there are no Relays connected, Turn on Relay # function will not display in drag down list. The Relay number will depend on how many Relays are connected.

3. Specify to either schedule it weekly or one time. Click to make a selection.
4. Click on the blocks to set the schedule (see also [Chapter 5.5.1](#)). Or click **All** to select all. To store the setting, click **Save**. To remove the settings, click **Clear**.

- To end Schedule Setting, click **OK** to exit and accept the setting and **Cancel** to exit without saving the setting.

5.5.1 To set schedule at a specific portion of time in that hour:

- Right click** the colored blocks.
- In the Select time dialog box, click to enable or disable the portion you want to set.
- Click **OK** to accept the setting and **Cancel** to exit without saving the setting.

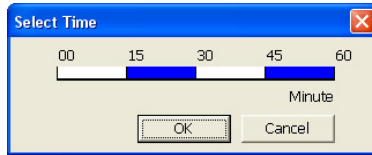

5.6 Backup Setting

In the Backup Setting dialog box, the number from 00 to 23 represent the time in 24-hour clock. The numbers from 01 to 16 represent the camera number. When you back up the file, you may find QLog Viewer and Player application included in the backup folder (see also [Chapter 6](#)).

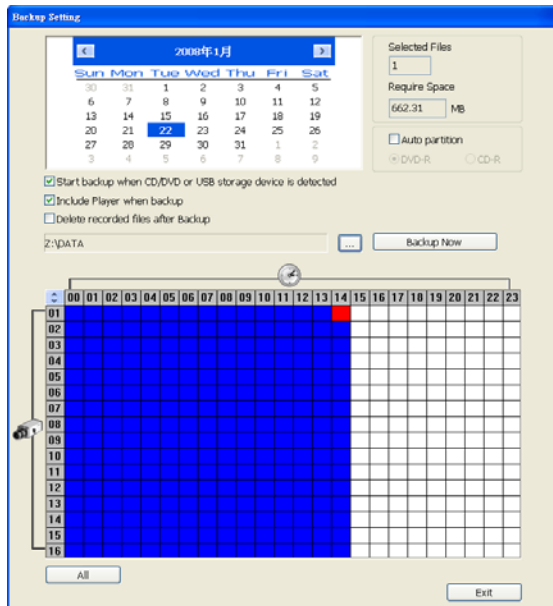

To Backup file:

1. Select the date of the recorded file in the calendar you want to backup. Use and buttons to shift the calendar to the left or right.
2. In the table below, click on the blue block to select the recorded file or click camera (01~16) or time (00~23) to select the whole row or column. The blue block turns red when it is selected. The block that appears in white doesn't have data. If you want to set the specific time, right-click on the selected block. Then, set the time to start and end.
3. Check the information beside the calendar.

Selected Files : Show the number of files selected.

Require Space : Show the total size of the selected file.

4. Enable **Auto partition** and select to divide the file size into DVD-R or CD-R. DVR automatically backup and divide the file sizes to facilitate burning into DVD or CD disc.
5. Enable **Start backup when CD/DVD or USB storage device is detected** that the Backup setting windows will display on screen automatically when the DVR system detects CD/DVD-ROM disk or USB storage device. Right after user select the period of backup file, click , the DVR system will start backup without confirmation.
6. Enable **Include player when backup** that will included a **Qplayer** program for playback backup file in backup folder when backup. Only administrator user has the authority to enable or disable this function.
7. If you do **NOT** want to keep the recorded file in the storage folder, enable **Delete files after Backup** check box.
8. Click to set the path on where to store the backup file.
9. Click to start archiving the selected file.

- In the Processing... dialog box, to stop archiving press **Abort**. When done, in the Backup Path list, shows the archived item. To burn the file in CD, you need to have NERO 6 or above installed in your PC then select the item in the list and click **Burn**. Click **Exit** to end this procedure and burn it later.

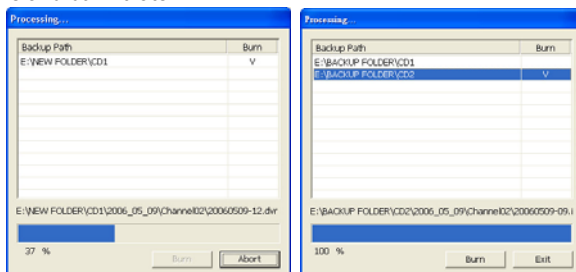

- In CD/DVD Backup, enable/disable Delete file after burning check box to remove the archived file after burning. Click **Burn** to start and **Exit** to cancel this process.

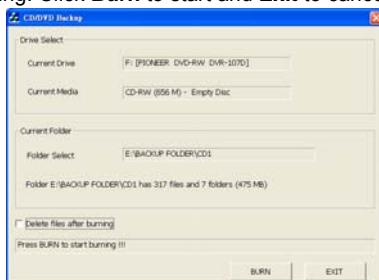

5.7 Sensor Setting

The I/O device must be installed to use this function. The DVR system also support external I/O box and user can install external sensors. For external sensor setting, please referring to the sensor vendor user's manual.

To Set the Sensor Setting:

- Click the drop-down list and select the sensor ID number.
- Enter sensor name.
- Click **External IO** to configure external I/O device if it is available(see also [5.7.1](#))
- The system automatically detects the sensor and input relates information. In the Content section, enter sensor description.
- In the test section, click **Test** to check the sensor status. Red is high and Green is low.
- Click **OK** to exit and accept the setting and **Cancel** to exit without saving the setting.

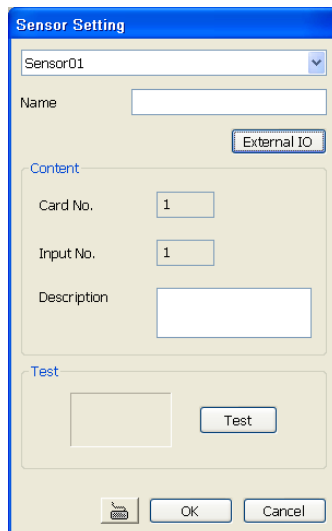

5.7.1 To Setup External I/O Box

The DVR system can connect the external I/O box for more installed of I/O devices.



1. Click **Add**.
2. Mark **Enable** box to enable this external I/O box.
3. Select the Brand of external I/O box from drag down list.
4. In **Port Setting**, different brand of external I/O box may have different port parameters. Please refer to the external I/O box's user manual for port setting information. Using the default value if user uses AverMedia External I/O box.
5. Click **OK** to save the setting.
6. To add more than one external I/O box, click **Add** and follow the above step 2~4.

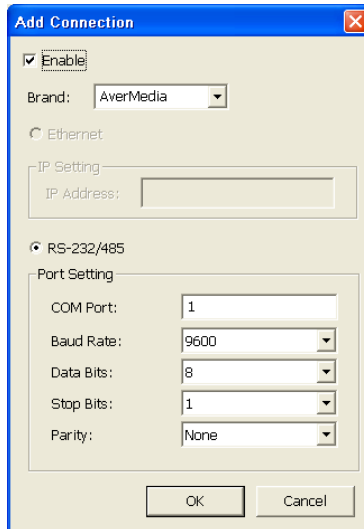

7. In External I/O box setup dialog, user will see all added External I/O. Click added External I/O box and click **Add** to scan the connected relays and sensors.
8. In **Add Module** windows, click **Scan** to scan the connected relays and sensors on the External I/O box.

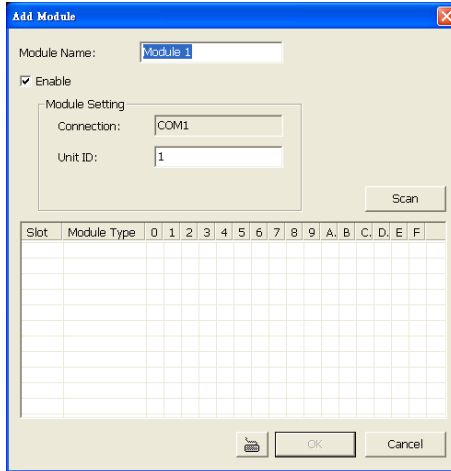

9. All connected relays and sensors will be listed. User can click radio button to control relays' status. And then, click **OK** to save the setting and click **Cancel** to exit and without saving.

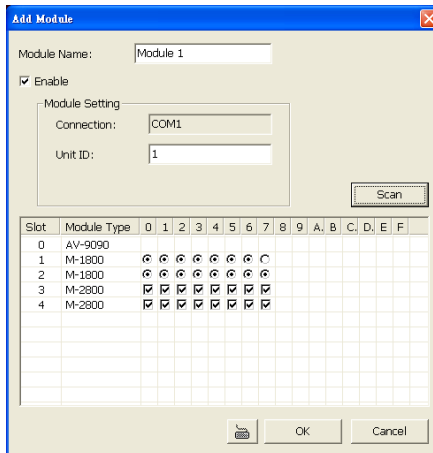

10. All connected External I/O box and their modules will be listed as tree topology in External I/O Setup windows.

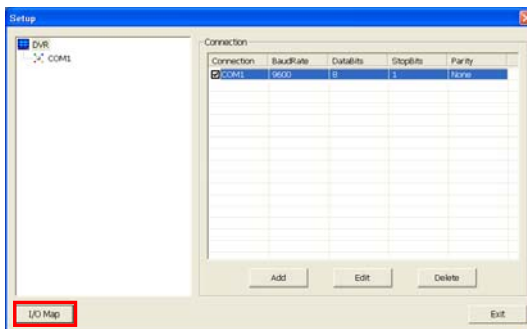

11. To view the all I/O devices information, click **I/O Map**.

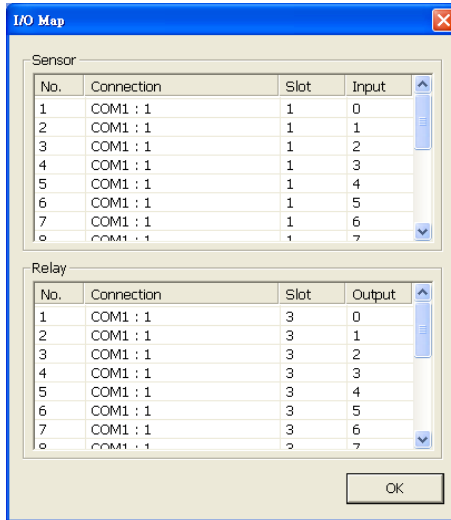

The I/O Map dialog box contains two tables. The top table, titled 'Sensor', lists 8 sensors with columns for No., Connection, Slot, and Input. The bottom table, titled 'Relay', lists 8 relays with columns for No., Connection, Slot, and Output. Both tables show connections to COM1:1 and slots 1 and 3.

Sensor			
No.	Connection	Slot	Input
1	COM1 : 1	1	0
2	COM1 : 1	1	1
3	COM1 : 1	1	2
4	COM1 : 1	1	3
5	COM1 : 1	1	4
6	COM1 : 1	1	5
7	COM1 : 1	1	6
8	COM1 : 1	1	7

Relay			
No.	Connection	Slot	Output
1	COM1 : 1	3	0
2	COM1 : 1	3	1
3	COM1 : 1	3	2
4	COM1 : 1	3	3
5	COM1 : 1	3	4
6	COM1 : 1	3	5
7	COM1 : 1	3	6
8	COM1 : 1	3	7

5.8 Relay Setting

The I/O device must be installed to use this function.

To set the Relay Setting:

1. Click the drop-down list and select the relay ID number.
2. Enter sensor name.
3. Click **External IO** to configure external I/O device if it is available(see also [5.7.1](#))
4. The system automatically detects the card and input number. In the Content section, enter sensor description.
5. In the test section, click **Test** to check the relay status. Red is high and Green is low.
6. Click **OK** to exit and accept the setting and **Cancel** to exit without saving the setting.

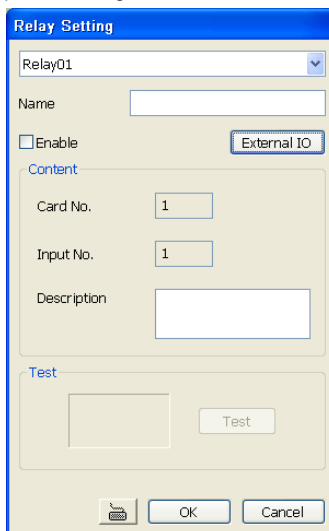

The Relay Setting dialog box features a dropdown menu for 'Relay01', a text field for 'Name', an 'Enable' checkbox, and an 'External IO' button. It is divided into 'Content' and 'Test' sections. The 'Content' section includes fields for 'Card No.' (1), 'Input No.' (1), and 'Description'. The 'Test' section includes a 'Test' button. At the bottom are 'OK' and 'Cancel' buttons.

5.9 Alarm Setting

In the Alarm Setting dialog box, click **Add** to insert and set new alarm setting, click **Delete** to remove the selected alarm setting, click **OK** to exit and save the setting, **Cancel** to exit without saving, and **Default** to revert back to original factory setting.

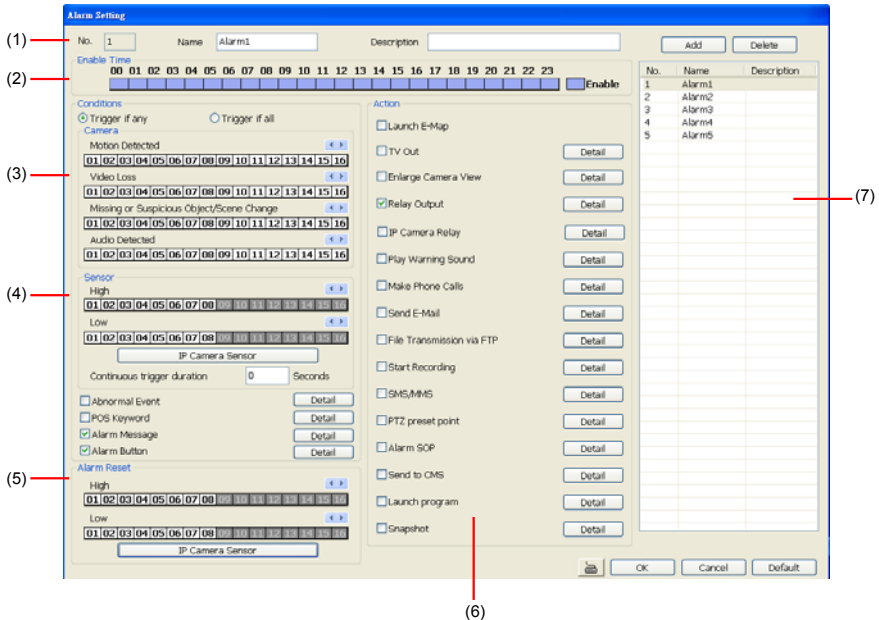

To set the Alarm Setting:

- Click **Add** to insert and set a new alarm setting. Click the items in the **(7) Alarm Setting List**, if you want to modify the alarm setting.
- In **(1) Alarm Setting number/Name/Description**, display the selected alarm setting number in the list below. Enter alarm name and description.
- In **(2) Enable Time**, the number from 00 to 23 represent the time in 24-hour clock. Select the time and click the block you want to activate or deactivate the alarm function. When it is deactivated the color of the block turns white.
- In **(3) Conditions**, you can set **“Trigger if any”** to activate if it falls to one of the conditions or **“Trigger if all”** to activate if it falls to all conditions.
 - In Camera section, select and click on the camera number (01 to 16) in **Motion Detected** and **Video Loss** to set the condition for the system to alarm.
 - In **Missing and Suspicious Object Detected**, click the camera number (01 to 16) and select the certain object on the screen (right click on camera number for detailed setting), and when the certain object is missing or doubtful, the system will alarm. (see also [Chapter 5.9.12](#)) In **Scene Change**, when the camera has been moved, the system will alarm, too.
 - In **Audio Detect**, click the camera number (01 to 16) to the system to alarm when detect the abnormal audio.
- In **(4) Sensor**, select and click on the sensor number (use ◀ and ▶ to select the sensor) to set the condition for the system to alarm. If the sensor normal status is high, set the sensor condition to low (see [chapter 5.7 step #4](#)).
Click **IP Camera Sensor** to configure IP camera's sensor condition. To set the sensor

condition for the system to alarm, click **High** or **Low** column. The column with a circle means is selected.

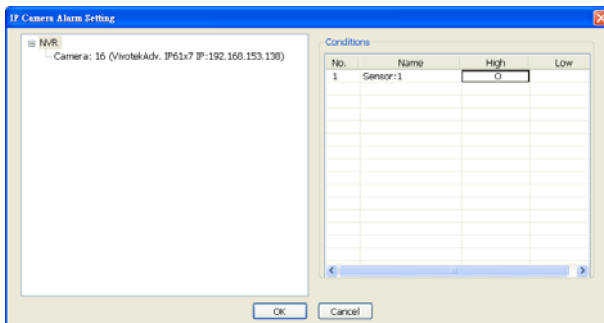

- Enable/disable the **Abnormal Event** check box, to set the condition of the event for system to alarm.

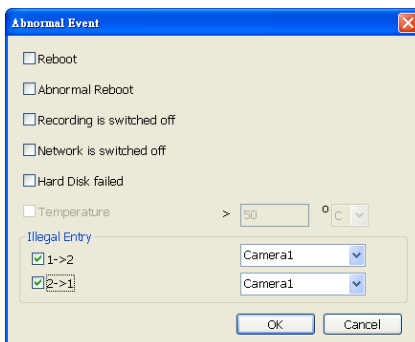

- **Reboot:** when the DVR system reboot without abnormal condition, the system will send out the alarm message.
- **Abnormal Reboot:** when the DVR system reboot in irregular condition, the system will send out the alarm message.
- **Recording is switched off:** when the recording has been stopped, the system will send out the alarm message.
- **Network is switched off:** when the network connection of DVR system is lost, the system will send out the alarm message.
- **Hard Disk failed:** when the hard disk can't work normally, the system will send out the alarm message.
- **Temperature:** set a temperature limited of system for system to alarm. When DVR system temperature is over the temperature limited, the system will send out the alarm. The system supports °C and °F temperature mode.
- **Illegal Entry:** any objects move between selected regions which user has set up in **Object Counting** section (see [Chapter 5.2.1](#)), the system will send out the alarm. Select the entry (object moves from region 1 to 2 or from region 2 to 1) and camera for system alarm detection.



Only the camera has been setup in **Object Counting** will be available for selecting in **Illegal Entry**.

- Enable/disable the **POS Keyword** check box, to scan the data from the POS if it matches the keyword (see also [Chapter 5.9.10](#)).

- Enable/disable the **Alarm Message** check box, to active with external alarm message by your own program. For the detail configuration, please contact the local reseller.
- Enable/disable the **Alarm Button** check box, to active manual alarm function (see also [Chapter 4.3#\(17\)](#)). To define alarm message of manually alarm trigger. Click alarm button and select the alarm button # and fill in the description of alarm button. Once the Alarm button has been activated and defined, the Alarm button will display on Advanced UI.

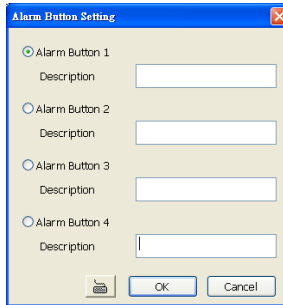

- **Continue trigger duration:** Set a time period that when sensor has been trigger and stay in the same status for that period, then the alarm will be sent out.
6. In **(5) Alarm Reset**, click the camera number (use ◀ and ▶ to select the alarm) to set the reset condition of alarm. Once alarm is reset, all alarm action will stop at the moment. If the sensor normal status is high, set the sensor condition to low. Click **IP Cam Sensor** to IP camera sensor reset condition. Click High or Low column to set the reset condition of alarm.

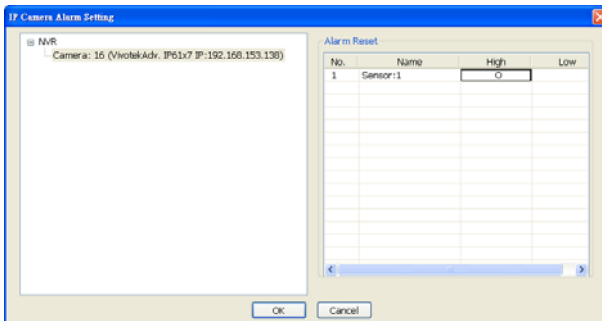

7. In **(6) Action**, you may now set the alarm action for the system to perform when the alarm condition is activated.
- **Launch E-Map**
Display mini Emap screen.
 - **TV Out**
Switch to only display the video on TV from where the alarm is activated or selected camera.
 - **Enlarge Camera View**
Switch to only display video in Preview/Advanced mode from where the alarm is activated.
 - **Relay Output**
Set to enable/disable the relay operation when the alarm is activated and to extend

- additional time in second before it stops the relay operation (see also [Chapter 5.9.1](#)).
- **IP Camera Relay**
Set to enable/disable IP camera relay trigger. Click **ON** column to enable/disable the relay trigger. The blank column means the trigger is off.

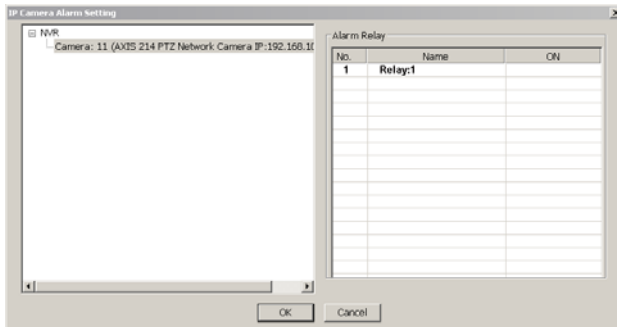

- **Play Warning Sound**
Play alarm sound. To setup click **Detail** (see also [Chapter 5.9.2](#)).
- **Make Phone Calls**
Dial and contact the number in the list. To setup click **Detail** (see also [Chapter 5.9.3](#)).
To use this feature, the PC must have a voice modem connected to it. The supported audio system is only 8KHz and 16Bit mono.
- **Send E-mail**
Send an electronic text message. To setup click **Detail** (see also [Chapter 5.9.4](#)).
- **File Transmission via FTP**
Upload file to remote computer thru FTP (File Transfer Protocol). To setup click **Detail** (see also [Chapter 5.9.5](#)).
- **Start Recording**
Record the video from the selected camera. To setup click **Detail** (see also [Chapter 5.9.6](#)).
- **SMS (Short Message Service)/MMS (Multimedia Messaging System)**
SMS transmits only text messages to mobile phone. MMS transmits text messages and images over wireless networks using the wireless application protocol (WAP).
Make sure your mobile phone support this feature and your PC is connected to GSM/GPRS modem. To setup click **Detail** (see also [Chapter 5.9.7](#)).
- **PTZ preset point**
Position the PTZ camera based on the preset point setting. To setup click **Detail** (see also [Chapter 5.9.8](#)).
- **Alarm SOP (Standard Operation Procedure)**
List the instructions to inform the person of what to do when the alarm is activated. To setup click **Detail** (see also [Chapter 5.9.9](#)).
- **Send to CMS (Central Management System)**
Enable/disable the selected camera to send video to CMS when the alarm is activated (see also [Chapter 5.9.10](#)).
- **Launch Program**
To call up the external program that is provided by 3rd party. Click **Detail** and click **...** to locate the program path. Enable **Multiple instance** check box to allow the program can be executed multiple times at the same time.

- Snapshot

Take a snapshot when the alarm is activated.

- a. **Select Camera:** specify which channel video to be snapshot when the alarm is occurred.
 - **Alarm Camera:** when a channel has an alarm occurred, and then, the DVR system will snapshot the channel video.
 - **Camera # (1~32):** the selected channel would be snapshot when an alarm is occurred.
- b. **Video Size:** select the size of snapshot picture.
- c. **Number of picture:** the number of picture that is going to be taken.
- d. **Snapshot Interval:** a time gap for next snapshot
- e. **Save Path:** a storage path for saving snapshot pictures.
- f. **Delete image after:** set a certain amount of snapshot image storage limit. When the snapshot image is over the limit, and then, the system will start recycle the snapshot image.

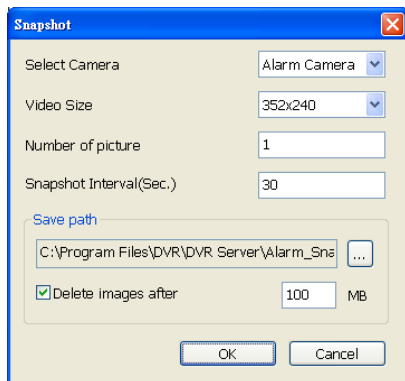

5.9.1 To Setup Alarm Relay:

1. Beside the Relay Output check box, click **Detail**.
2. In the Alarm Relay dialog box, select from the available relay list and in the ON column, set to enable/disable the relay operation when the alarm is activated. In the Retrieve time check box, you may enable/disable to extend the relay operation time and set the duration in second.
3. Click **OK** to exit and accept the setting and **Cancel** to exit without saving the setting.

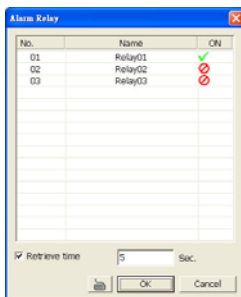

5.9.2 To Setup the Alarm Sound Setting:

1. Beside the Play Warning Sound check box, click **Detail**.
2. In the Alarm Sound Setting dialog box, click  to select other wav file from other source or folder, **Play** to listen, **Record** to make a new copy of a sound.
3. If you click **Record**, you will be prompted if you want to replace the file. Click **OK** to continue and **Cancel** to discontinue.
4. When the Sound Recorder appears, use the record control panel to record, stop, play, rewind and forward. If you want to keep the existing file, click **File > Save As...**, enter filename and click **Save**. Make sure you have microphone connected to your PC.

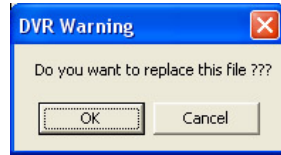
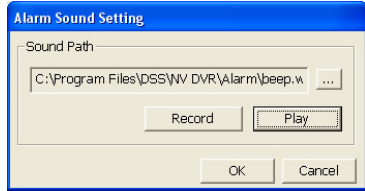

5. Click **OK** to exit and accept the setting and **Cancel** to exit without saving the setting.

5.9.3 To Setup Call Out List:

1. Beside the Make Phone Calls check box, click **Detail**.
2. In the Call Out List, click **Add** to insert a new contact number, **Modify** to edit the selected item, **Remove** to delete the selected item, **Test** to check if it is working.
3. In the Call Out Setting, enter the phone number and description. Click  to select existing sound recorded messenger and **Record** to make a new voice message.
4. When the Sound Recorder appears, use the record control panel to record, stop, play, rewind and forward. If you want to

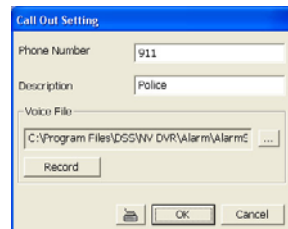
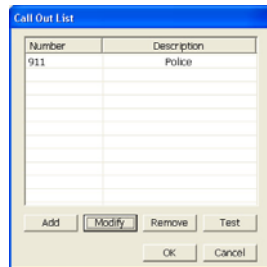

the existing file, click **File > Save As...**, enter filename and click **Save**. Make sure you have microphone connected to your PC.

The supported audio system is only 8KHz and 16Bit mono.

5. Click **OK** to exit and accept the setting and **Cancel** to exit without saving the setting.

5.9.4 To Setup Send E-mail Setting:

Beside the Send Email check box, click **Detail**. In the E-mail Setting dialog box, click **OK** to exit and save the setting and **Cancel** to exit without saving the setting.

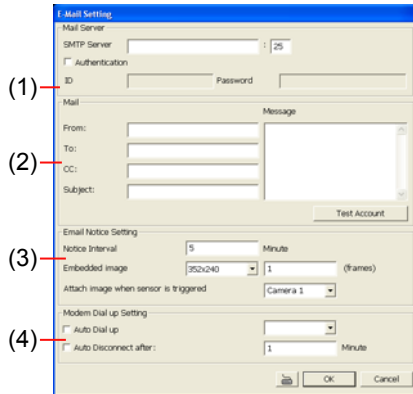

(1) Mail Server

Enter the SMTP Server and port. If your e-mail system requires user identification, enable **Authentication** check box and enter User ID and Password.

(2) Mail

To check if it is working, click **Test Account** button.

From: Enter the sender e-mail address.

To and CC: Enter the recipient email address and separate it with comma or a semicolon (;).

Subject: Enter the message title.

Message: Type the message.

(3) Email Notice Setting

Notice Interval: Set the period of time before it sends another e-mail notice.

Embedded image: Select the image size and set the number of frames.

Attach image when sensor is triggered: When the sensor is triggered, the system will capture the image and send the image to the certain e-mail address with the alarm message.

(4) Modem Dial up Setting

If you are using dial up modem, enable **Auto Dial up** check box and select the modem name. You may also set the time to disconnect automatically, just enable the **Auto Disconnect after** check box and set time.

5.9.5 To Setup FTP Setting:

1. Beside the File Transmission via FTP check box, click **Detail**.
2. In the FTP Setting dialog box, enter the FTP IP, port, user ID and password.
3. In **Number of Pic** text box, enter the number of sequence images that want to send when file is transmitting. The maximum number of picture can be transmitted are 16.
4. In **Upload image when sensor is triggered**, select the camera that the images will be capture and send when the sensor is triggered.

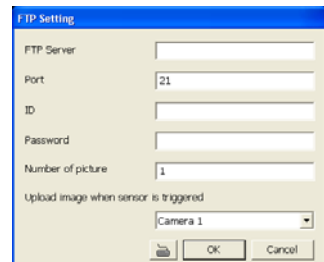

- Click **OK** to exit and save the setting and **Cancel** to exit without saving the setting.

5.9.6 To Setup Alarm Recording Setting:

- Beside the Start Recording check box, click **Detail**.
- In the Alarm Recording Setting dialog box, select the camera to enable/disable video recording. Enable **All** to select all cameras.
- In the Frame Rate selection, select **As Setting** to record the number of frames based on the Recording Setting or **Max** to record the maximum of frames based on the available speed (maximum is 32 pictures).

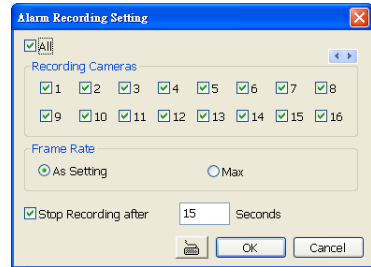

- In the **Stop Recording after** text box, mark and set the number in second for the program to continue recording after the alarm has ended. The time range is 1~600 seconds. If user doesn't mark and set the time, the alarm recording will continue recording until alarm is reset.
- Click **OK** to accept the new settings and **Cancel** to exit without saving.

5.9.7 To Setup SMS/MMS Setting:

To use this feature, GSM/GPRS modem is required. Connect the GSM/GPRS modem to the serial COMM port of PC. Beside the SMS/MMS check box, click **Detail**.

- Select the port number in ComPort drop down list from where the GSM/GPRS modem is connected.
- Click **Enter Pincode** button to enter the pin code of phone number if your phone system required.
- In **Phone Num** text box, enter the contact number.
- You may now set to send thru SMS &/or MMS. If you enable SMS setting, just enter the message in the text box.
- If you enable MMS, enter the **APN name**, **WAP IP**, **MMS address** and the message. Enter the **Login** account and **password** if required. If you are not sure, please contact your mobile service provider. The **Import...** button allows user to import the pre-saved configuration and also export the current configuration by clicking **Export...** button.
- Attach image when sensor is triggered:** Select the camera that the images will be capture and send when the sensor is triggered.
- Click **OK** to accept the new settings and **Cancel** to exit without saving.

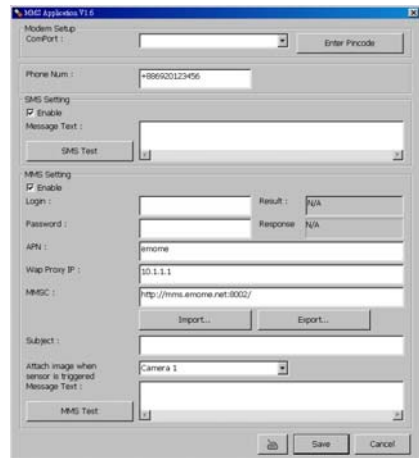

Make sure your ISP provider and cell phone provider both support JPG file format transmitting.

5.9.8 To Setup PTZ Preset Point:

Beside the PTZ preset point check box, click **Detail**. In the box, select the PTZ camera number then select the Enable the PTZ camera when the alarm is activated and ended. F user also can select one preset position or **Auto Path** between

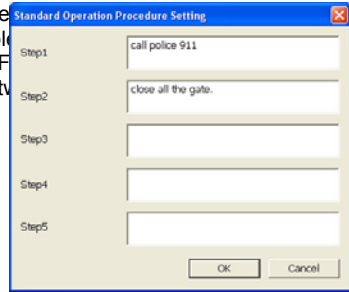

5.9.9 To Setup Alarm SOP:

Beside the Alarm SOP check box, click **Detail**. In the step text boxes, type the standard protocol when the alarm is activated. When the alarm is activated, the Standard Operation Procedure dialog box will appear. Just click **Next** to see the next instruction, **Back** to see the previous instruction, **Finish** to end and **Abort** to terminate.

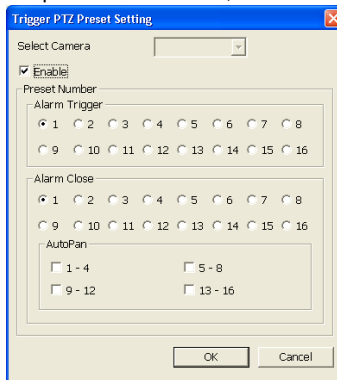

5.9.10 To Setup CMS Setting

Beside the Send to CMS check box, click **Detail**. In the CMS Setting, select the camera to enable/disable sending the video to CMS. Enable **All** to select all cameras. Then, click **OK** to accept the new settings and **Cancel** to exit without saving.

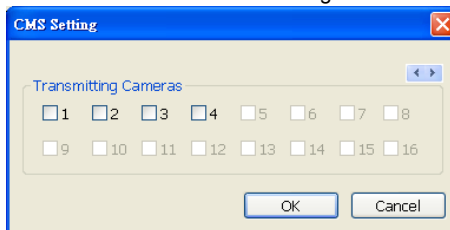

5.9.11 To Setup POS Keyword Setting

1. Beside the Send to POS Keyword check box, click **Detail**.
2. In the POS Keyword Setting, select the camera to enable/disable scanning the keyword. Enable **All** to select all cameras.
3. Enter the text below keyword text box. Click **Add** to include the keyword in the list. To remove, select the word in the list and click **Delete**. You may only add 8 keywords. User can define the color for each keyword. To set the color, click the color panel after next to POS keyword column and a color selection window will pop up. Select the color that user wants and click **OK**.

- Click **OK** to accept the new settings and **Cancel** to exit without saving.

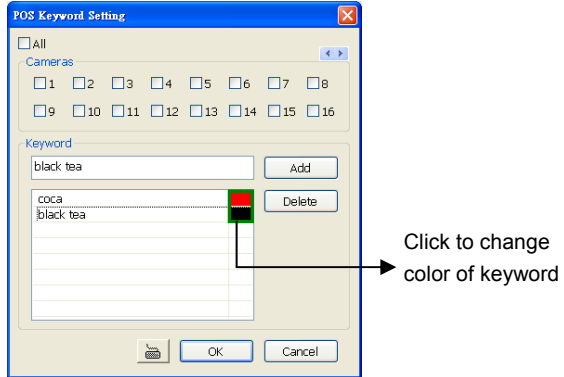

5.9.12 Missing, Suspicious Object, and Scene Change Detected

- Missing Object

Select the certain object on the screen for the system to detect; when the object is disappear or move and the system will alarm. Click **OK** to exit and save the configuration. To exam the setup condition, click **Start Test**.

- Select the camera number (0-16) and press RIGHT button on the mouse to call up the setup windows.
- Click **Save** to capture the image for comparing reference first. To view the captured image, enable the **Show Reference Image** check box. The captured image will display on screen. The reference image is sharing with the Suspicious Object and Scene Change function.
- Mark the **Enable** check box to setup the condition.
- Use the mouse to click and drag the frame on the screen. User can drag more than one frame.
- Sensitivity:** Set the system detects sensitivity.
- Delay Time:** Set the lasting time for system to detect the object.
- To reset all object frames, click **Clean**. To clean an object frame, click right button of mouse and drag the object frame that user want to clean.

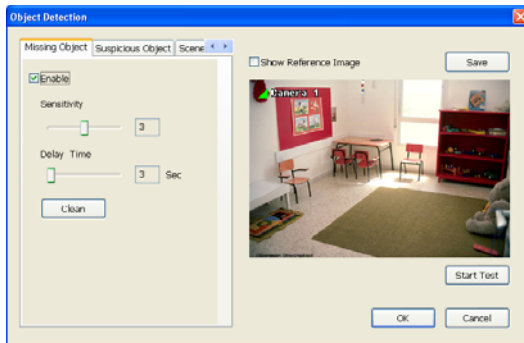

- Suspicious Object

Suspicious Object is including the object missing or the doubtful object appears on the screen. Click **OK** to save and exit the setup windows. To exam the setup condition, click

Start Test.

1. Select the camera number (0-16) and press right button on the mouse to call up the setup windows. And then, click the **Suspicious Object** Tab.
2. Click **Save** to capture the image for comparing reference. To view the captured image, enable the **Show Reference Image** check box. The captured image will display on screen. The reference image is sharing with the Missing Object and Scene Change function.
3. Mark the **Enable** check box to setup the condition.
4. **Sensitive:** Set the system detects sensitivity.
5. **Delay Time:** Set the lasting time for system to detect the object.
6. Use the mouse to click and drag the frame on the screen.
 - **Maximum_Object:** the maximum detect size. The objects are out of the maximum detect area will be disregard. Use mouse to click and drag the frame on the screen.
 - **Minimum_Object:** the minimum detect area. When the objects are smaller than the minimum detect area, the system will disregard. Use mouse to click and drag the frame on the screen.
7. **Enable Mask**
Mark an area on the screen to disregards the motion in the marked area and to only monitor outside the marked area. Mark the **Enable Mask** check box, click and drag the mask frame on the screen.
8. To reset all object frames, click **Clean**. To clean an object frame, click right button of mouse and drag the object frame that user want to clean

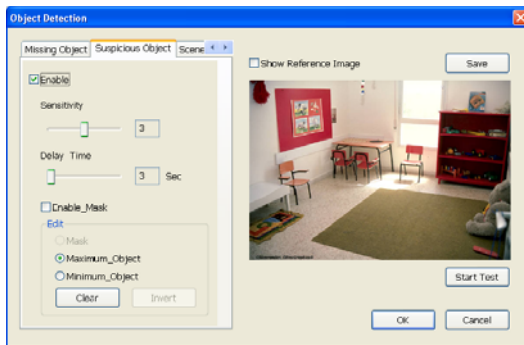

Scene Change

When the camera has been moved, the system will alarm.

1. Select the camera number (0-16) and press right button on the mouse to call up the setup windows. And then, click the **Scene Change** Tab.
2. Click **Save** to capture the image for comparing reference. To view the captured image, enable the **Show Reference Image** check box. The captured image will display on screen. The reference image is sharing with the Missing Object and Suspicious Object function.
3. Mark the **Enable** check box to setup the condition.
4. **Sensitive:** Set the system detects sensitivity.
5. **Delay Time:** Set the lasting time for system to detect the movement.
6. **Change Rate:** Set the camera movement range which compare with the original position.
7. **Enable Mask**
Mark an area on the screen to disregards the motion in the marked area and to only monitor outside the marked area. Mark the **Enable Mask** check box, click and drag the mask frame on the screen.
8. To reset all object frames, click **Clean**. To clean an object frame, click right button of mouse and drag the object frame that user want to clean.

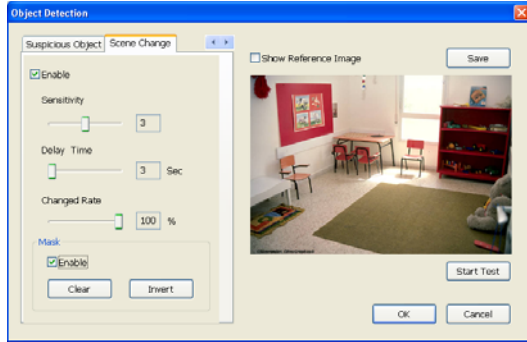

5.10 User Setting

Only administrator can access User Setting. The maximum user accounts are 256.

In the User Setting dialog box, click **Add** to insert a new user, **Delete** to remove the selected user, **Edit** to modify the user control right, **OK** to exit and accept the setting, and **Cancel** to exit without saving the setting.



After clicking **Add** or **Edit**, you may customize the user control setting. **OK** to exit and accept the setting, and **Cancel** to exit without saving the setting

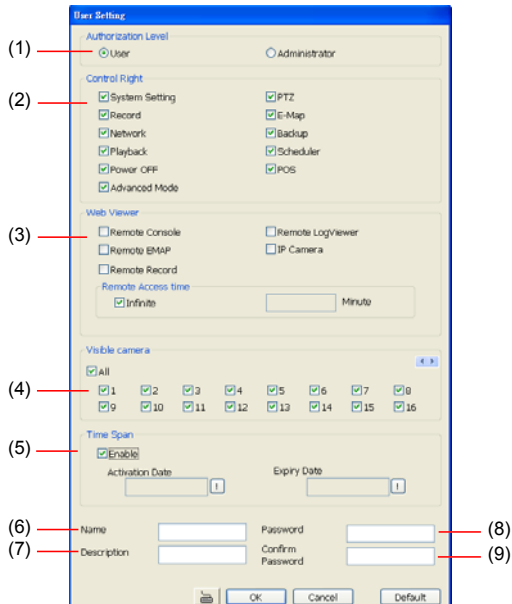

(1) Authorization level

Select the status of the user. Only Administrator-level can access User Setting, and reset the Alarm status when using the Remote Console.

(2) Control Right

Enable the items that would allow the user to access.

(3) Web Viewer

Enable/disable Web Viewer control right that allow the user to operate from a remote location using internet explorer.

- Remote Console

Allow the user to remote modify DVR system setting.

- Remote LogViewer

Allow the user to view the event log from remote site.

- Remote EMAP

Allow the user to view the E-map of DVR from remote site.

- IP Camera

Enable/disable user to add new IP camera when using the Web Viewer.

- **Remote Access Time**

Enable **Infinite** check box to access DVR without time limit. If you want to set time limit, enter the number of minutes in **Minute** text box.

(4) Visible Camera

Select the camera number that would allow the user to access or view. To select all the cameras, enable the **ALL** check box.

(5) Time Span

Set the user account a specific time period that user only can use given account to login DVR program in that specific period. Mark **Enable** check box and select the **Activation Date** and **Expiry Date**.

(6) Name

Enter the user name.

(7) Description

Enter the user description.

(8) Password

Enter the user password.

(9) Confirm Password

Enter the same user password for confirmation.



Chapter 6 Backup Video Players

You can playback the backup files using QPlayer applications. When you back up the recorded file, QPlayer applications are automatically included in the backup folder. With QPlayer, it is the same as in Playback mode and supports six (6) different split screen types to view all the video at the same time. User even can select the different language of display UI. The only difference is that there are no Preview and Playback buttons. To run the application, go to backup folder and double-click Q Player icon.

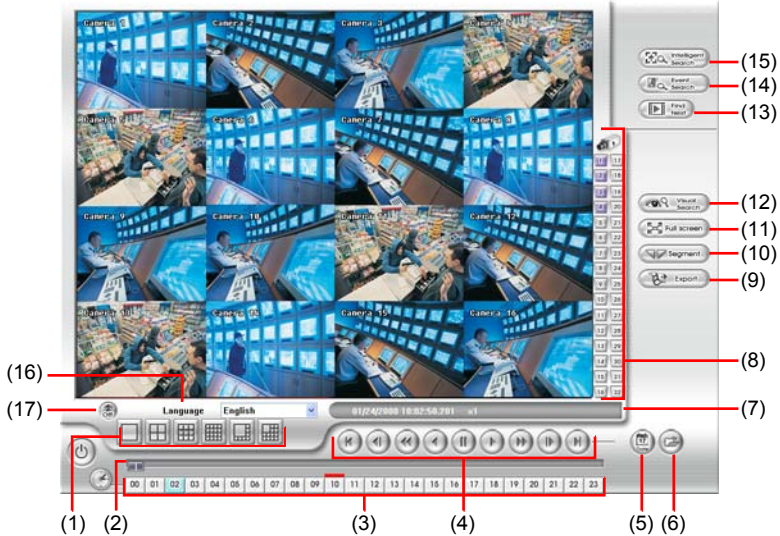
6.1 Familiarizing QPlayer Buttons



Name	Function
(1) Split Screen Mode	Select from six (6) different split screen type to playback the recorded video file of all the camera, or one camera over the other or alongside on a single screen.
i	<ul style="list-style-type: none"> - If there are only 4 cameras, you won't be able to switch to 9, 16, and 13 split screen mode. - To zoom in an area on the screen, Right click and Drag a square on the area you want to enlarge.
(2) Progress bar	Show the progress of the file being played. You may move the bar to seek at any location of the track.
(3) Hour Buttons	Select and click to playback the recorded video file on the specific time frame.
i	The Hour buttons represent the time in 24-hour clock. The blue bar on top of the hour button indicates that there is a recorded video file on that period of time. While the red bar indicates that you are currently viewing the recorded video file.
(4) Playback Control Buttons	<p>Begin: Move at the beginning of the recorded video file.</p> <p>Previous: Go back to the previous frame.</p> <p>Slower: Play the recorded video file at the speed of 1/2X, 1/4X, or 1/8X.</p> <p>Rewind: Wind back the recorded video file.</p> <p>Pause: Briefly stop playing the recorded video file.</p>

Name	Function
(4) Playback Control Buttons	<p>Play: Play the recorded video file.</p> <p>Faster: Play the recorded video file at the speed of 2x, 4x, 8x, 16x or 32x.</p> <p>Next: Go to the next frame.</p> <p>End: Go to the end of the recorded video file.</p>
(5) Date	Select the date on the calendar and the time from 00 to 23 to where to start playing the recorded video file.
	<p>The numbers from 00 to 23 represent the time in 24-hour clock. The numbers from 01 to 16 represent the camera ID. The blue colored column indicates that there is a recorded video file on that period of time. While the red colored column indicates on where to start playing the recorded video file.</p>
(6) Open	Access the backup video file.
(7) Status bar	Display the recorded date, time and play speed.
(8) Camera ID	Show the number of cameras that are being viewed. When you are in single screen mode, click the camera ID number to switch and view other camera.
(9) Export	<p>Export includes Snapshot, Print, Output Video Clip, and Backup function.</p> <ul style="list-style-type: none"> ■ Snapshot: Capture and save the screen shot either in *.jpg or *.bmp format. ■ Print: Print the screen shot. ■ Output Video Clip: Save the segmented file in *.mpg, *.avi, or *.dvr format (see also Chapter 4.8).
(10) Segment	Keep a portion of the recorded video (see also Chapter 4.8).
(11) Full screen	View in Playback-compact mode. To return, press the right button of the mouse or ESC on the keyboard or click the arrow icon.
	<p>Click the arrow icon to escape from full screen display mode</p>
	<p>When you switch to full screen in multiple-screen mode, Left click to toggle to only display one of the video in the multiple-screen mode or all.</p>
(12) Visual Search	Search from a specific camera by Date, Hour, Minute, 10 Seconds and Second. (See also Chapter 4.10)

Name	Function
(13) Find Next	Search for the next event or changes in the motion detector frame. You can use this when you are using Intelligent Search or Event Search function.
(14) Event Search	Search from the recorded activities that take place in the system (i.e., Sensor, Motion, Video Loss, POS). (See also Chapter 4.11)
(15) Intelligent Search	Search the changes in the motion detector frame (See also Chapter 4.12).
(16) Language	Select the UI display language.
(17) De-interlace	To enhance the video quality. Set the de-interlace mode to #1, if you are capturing motionless picture and #2, if it captures lots of movement.

Chapter 7 Using Functional Keys

The DVR system provides shortcut keys. The table shows the function keys and descriptions.

Function Keys	description
Q	Exit System
F1	Display system information
F2	Start recording
F3	Enable network function
F4	Access system settings
F5	Switch to playback mode
F6	Access E-map setting
F7	Access PTZ camera control panel
F8	Snapshot
F9	Switch to Full Screen
F11	Switch to AutoScan
CTRL + F	Freeze function
CTRL + B	Quick Backup
Ctrl + A	Turn on/off hardware AGC (Auto Gain Control)

Chapter 8 Using the Remote Programs

You can use Microsoft Internet Explorer to access DVR server by entering the IP address or domain name. To use this feature, make sure that you are connected to the internet and the Network feature is enabled.

Accessing this feature for the first time you will be prompted by your browser to install WebCamX.cab, allow the installation and you should be able to connect and login afterwards. For Windows 2000, click **Yes** when the Security Warning dialog box appears.

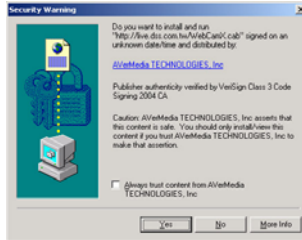

For Windows XP, click **Install** when the Internet Explorer - Security Warning dialog box appears.

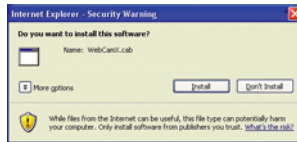

After installing the WebCamX.cab and when connecting to the DVR server, you are required to enter User ID, password and select the network type.

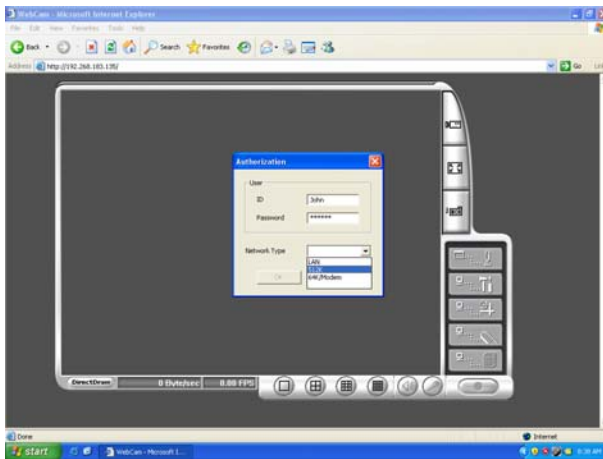

If you are not in a LAN network environment, remote playback video may be unsmooth due to network speed limitation. Slow network transmission speed may possibly cause system performance drop as well.

Chapter 8 Using the Remote Programs

8.1 Familiarizing the DVR WebViewer Buttons

Right-clicking on the webcam video screen, enables you to start video recording, change video quality, switch camera and enable/disable DirectDraw.

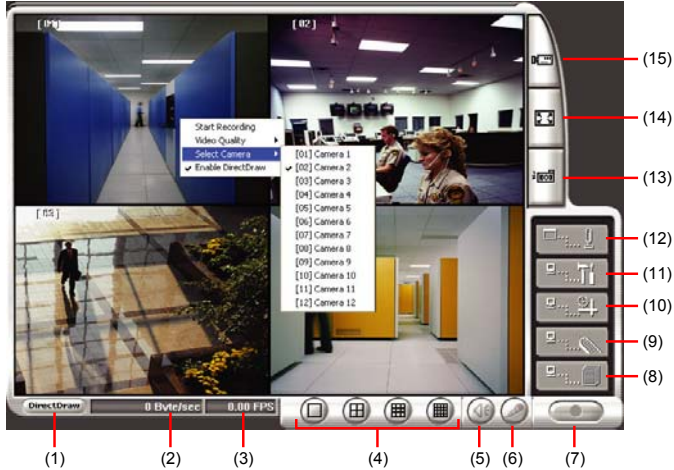

Name	Function
(1) DirectDraw	Enhance the video quality.
<p>i Not all graphic cards can support this function.</p>	
(2) Received file size	Indicate the size of the data being sent per second.
(3) Camera frames	Indicate the number of frames per second.
(4) Split display mode	Select from six different split screen types to view all the cameras. It also allows you to switch and view different camera number. To view 32 channels, click 16 split screen button to switch channel display.
(5) Audio	Enable/disable remote sound.
(6) 2-Way Talk	Enable/disable 2-way audio function. This function allows the client and server to talk via internet using MIC. Make sure your microphone and speakers work before using this function. If the DVR server Talk to web-client setting is disabled, you won't be able to hear from the other side.
(7) Record	Save the video of the selected camera in AVI format.
(8) Event Log Viewer	Display the Event logs, Operation logs, POS logs, System logs, and Network logs.
(9) Remote Console	Initiate Remote Console. The interface is the same as DVR application and allows you to control DVR server (see also Chapter 8.2).
<p>i If you are using Windows Vista, please make sure you execute IE as system administrator. To execute IE as system administrator, please right click on IE shortcut icon and select "To execute as Administrator".</p>	
(10) Remote E-Map	Display the DVR server Emap screen (see also Chapter 4.7).
(11) Remote setup	Change the DVR server settings (see also Chapter 8.1.1).
(12) Select a PTZ	Initiate PTZ camera controller (see also Chapter 8.2)

Name	Function
camera	
(13) Snapshot	Capture and save the screen shot in *.bmp format.
(14) Full screen	Use the entire area of the screen to only display the video. To return, Right click the mouse or press ESC on the keyboard.
(15) Select cameras to view	Select to the view camera from different server. In Select Camera dialog box, Display column, click to enable/disable viewing the camera. In Video Quality column, click to select between High, Normal or Low. <ul style="list-style-type: none"> - Click Add Server and select the server type between DVR and IP Cam to add. - Click Delete Server to delete the selected item. - Click Import to replace it with the previous saved list. - Click Export to save the list. - Click Apply All to change all the camera video quality based on the selected setting. - Click OK to exit.

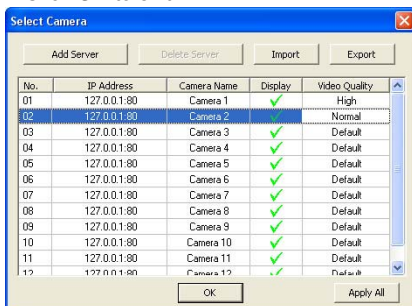

To add IP Cam, user need to enable IP Camera control right at the **User setting** of DVR system.(see [5.10](#))

8.1.1 To Setup Remote System Setting

Click **OK** to exit and save the setting and **Cancel** to exit without saving the setting. The setting here applies to Remote DVR only.

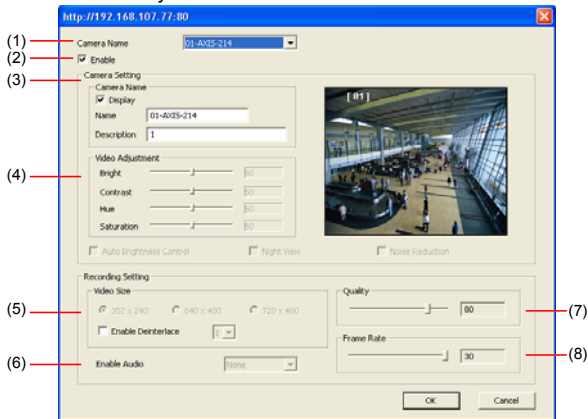

(1) Camera Name

Select the camera you want to adjust the settings.

(2) Enable

Set to enable/disable the selected camera. When there is no video source on the camera, we suggest disabling it so that the system won't detect it as video loss error.

(3) Camera Name

- Display

Enable/disable to show the video. Even if the video of the selected camera is hidden you can still record the video and preview it in playback mode.

- Name

Change the camera name.

- Description

Add a short comment.

(4) Video Adjustment

Adjust the Brightness, Contrast, Hue and Saturation of the selected camera.

(5) Recording Setting

Select the size of the video and click the button. The higher the size, the larger the file it create. You can also activate the **Enable Deinterlace** to enhance the video quality. Set the **Enable Deinterlace** mode to #1, if you are capturing motionless picture and #2, if it captures lots of movement.

(6) Enable Audio

Select to assign the audio channel of the selected camera. You can only assign one audio channel to one camera source. This way you can record both audio and video.

(7) Quality

Adjust the video quality. The higher the value, the lower the compression level and uses more hard disk space.

(8) Frame Rate

Set the number of images per second of the video to be recorded. The frame rate ranges from 1 to 30 for NTSC and 1 to 25 for PAL. The higher frame rate, it uses more hard disk space.

8.2 Familiarizing the WebViewer PTZ Buttons



Name	Function
(1) Direction buttons	Adjust and position the focal point of the PTZ camera. Click the center to pan automatically.
(2) Select PTZ	Choose to enable/disable the PTZ camera. In the Select PTZ dialog box, Select column, click to enable/disable viewing and controlling the PTZ camera. Click OK to exit and save the setting and Cancel to exit without saving the setting.
(3) AutoPan Groups	Operate the PTZ cameras automatically based on the selected camera group preset position number.
(4) Camera preset position number	Move the PTZ camera to the preset point. The camera position number is setup in DVR site(see 4.13.1#5)
(5) Zoom +/-	Zoom in and out the image.
(6) Focus +/-	Adjust the focus manually to produce clear image.

8.3 Familiarizing the Remote Console Buttons

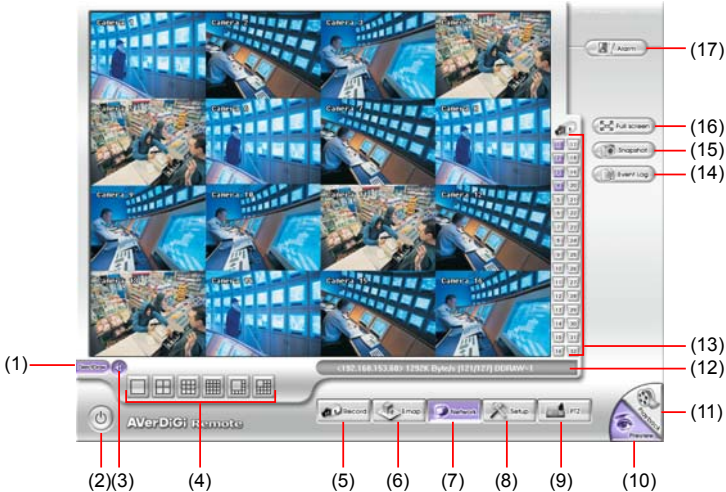

Name	Function
------	----------

(1) DirectDraw Enhance the video quality.



Not all graphic cards can support this function.

(2) Exit Close the Remote Console.

(3) Volume Enable/disable the sound.

(4) Split Screen Mode Select from six (6) different split screen type to playback the recorded video file of all the camera, or one camera over the other or alongside on a single screen.
To view 32 channels, click 16 split screen button to switch channel display.



If there are only 4 cameras, you won't be able to switch to 9, 16, and 13 split screen mode.
To change the video quality, right-click on the screen and select between High, Normal or Low.

(5) Record Start/stop video recording.

(6) Emap Display the map in each area, the camera/sensor/relay location and the warning event. (see also [Chapter 4.7](#))

(7) Network Enable/disable remote system access. This feature allows you to access DVR server from a remote location via internet connection.

(8) Setup Configure the Remote Console setting. (see also [Chapter 8.3.1](#))

(9) PTZ Access PTZ control panel. Beside PTZ camera, NV DVR system also support mega pixel IP camera.(see [Chapter 8.4](#))

(10) Preview Switch to Preview/Advanced mode. This allows you to view live camera display.

(11) Playback Switch to Playback mode. This allows you to view the recorded video file. (see [Chapter 8.4](#))

(12) Status Bar Display the IP address and received file size.

Name	Function
(13) Camera ID	Show the number of cameras that are being viewed. When you are in single screen mode, click the camera ID number to switch and view other camera.
(14) Event log	Show the record of activities that take place in the system. To filter the records, select and click the option button to only display Event, System, Operation, Network or POS.
(15) Snapshot	Capture and save the screen shot either in *.jpg or *.bmp format.
(16) Full screen	Use the entire area of the screen to only display the video. To return, Right click the mouse or press ESC on the keyboard.
(17) Alarm	Alert and display warning info. Only Administrator-level can reset and turn on, off and trigger the Sensor and Relay by right-clicking the item in the Sensor and Relay list.

8.3.1 To Setup Remote Console Setting

Click **OK** to exit and save the setting and **Cancel** to exit without saving the setting.

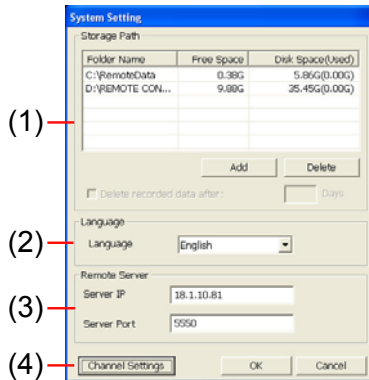

(1) Storage Path

Set the directory on where to save the data. When there is not enough free space to record one hour data, the system automatically replaces the oldest data. In case you have more than one storage path, the system automatically saves the data to the next storage path.

By default the data is stored in C:\RemoteData, to insert another storage path, click **Add**. To remove the selected path, click **Delete**.

If you want the system to automatically erase the data after a certain days, enable the **Delete recorded data after** check box and enter the numbers of days in **Days** text box.

(2) Language

Customize the system to display the tool tips and dialogs based on the selected language. By default the language is in English.

(3) Remote Server

Enter the DVR Server IP and Port number.

(4) Channel Settings

The numbers from 01 to 16 represent the camera ID. In Transmitting Channels section, enable the camera number to receive the camera signal from the server. In Visible Channels section, enable the camera number to view the camera signal on Remote Console screen. To select all the cameras, enable the **ALL** check box.

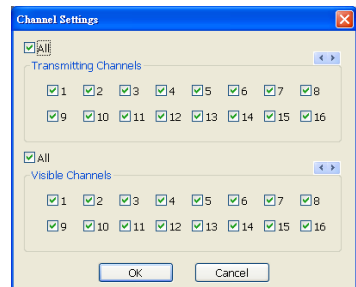

8.4 Familiarizing the Buttons in PTZ Camera Controller

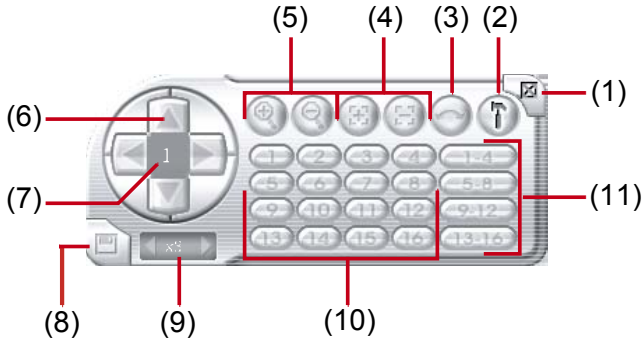

Name	Function
(1) Close	Exit PTZ camera controller.
(2) Setup	Configure PTZ cameras.(also see Chapter 4.13)
(3) AutoPan	Operate the PTZ cameras automatically based on the selected camera group preset position number.
(4) Focus +/-	Adjust the focus manually to produce clear image.
(5) Zoom +/-	Zoom in and out the image.
(6) Direction buttons	Adjust and position the focal point of the PTZ camera.
(7) Camera ID pane	Display the PTZ camera number that is being operated.
(8) Save Camera preset position	Save the PTZ camera preset position number. Select the camera and click the preset position number and save it.
(9) Camera lens speed controller	Adjust the moving speed of the PTZ camera lens.
(10) Camera preset position number	Move the PTZ camera to the preset point.
(11) Group AutoPan	Select to automatically operate PTZ camera in group.

8.5 Using the Remote Playback

To use this feature, first you need to select the source of the file. In the Select Playback Mode dialog box, choose **Local Playback** to open the file that is recorded in the Remote Console, and **Remote Playback** to open the file that is recorded in the DVR server. When you choose Remote Playback, select **RealTime Playback** if your internet bandwidth is fast and big enough, otherwise choose **Download and Playback**.

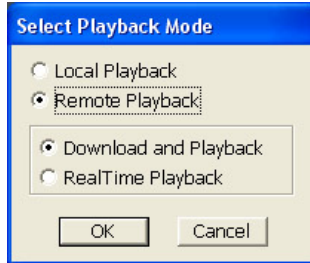

Click **OK** to proceed and **Cancel** to void this operation.

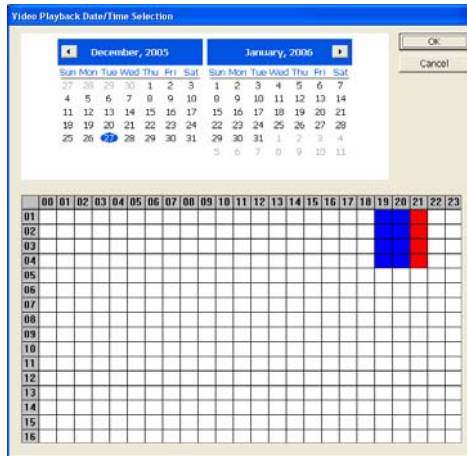

In the Video Playback Date/Time Selection, the number from 00 to 23 represent the time in 24-hour clock. The numbers from 01 to 16 represent the camera number.



To Make a Selection:

5. Select the date in the calendar. Use  and  buttons to shift the calendar to the left or right.
6. In the table below, click on the blue block to select and open the recorded file. The blue block turns red when it is selected. The block that appears in white doesn't have data. You can only select one block when you choose Download and Playback.
7. Click **OK** to proceed and **Cancel** to void this operation.
8. If you select Download Playback and after making the selection, the system divides the selected hour into 16 video thumbnails. In the Time Selection screen, click on the video thumbnail you want to download and open (see also [Chapter 8.4.2](#)).



8.5.1 Familiarizing the Local Playback Buttons

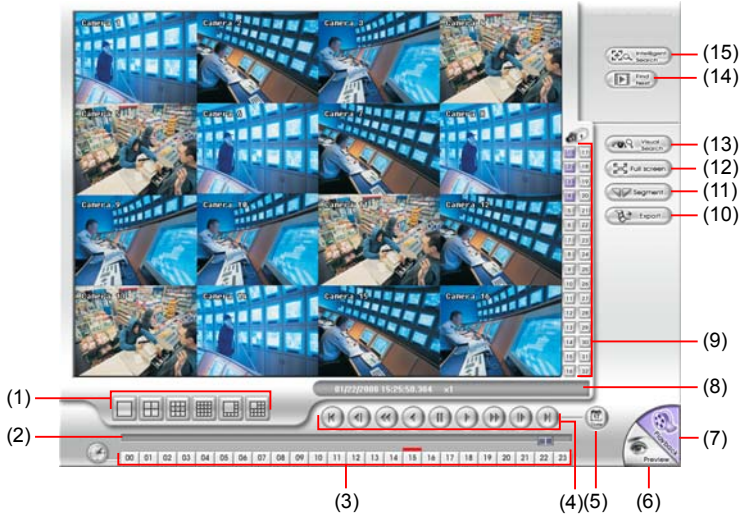

Name	Function
------	----------

(1) Split Screen Mode
 Select from 6 different split screen types to playback the recorded video file of all the camera, or one camera over the other or alongside on a single screen.
 To view 32 channels, click 16 split screen button to switch channel display.





- If there are only 4 cameras, you won't be able to switch to 9, 16, and 13 split screen mode.
- To zoom in an area on the screen, **Right click** and **Drag** a square on the area you want to enlarge.

(2) Progress bar
 Show the progress of the file being played. You may move the bar to seek at any location of the track.

(3) Hour Buttons
 Select and click to playback the recorded video file on the specific time frame.





The Hour buttons represent the time in 24-hour clock. The blue bar on top of the hour button indicates that there is a recorded video file on that period of time. While the red bar indicates that you are currently viewing the recorded video file.

Name	Function
(4) Playback Control Buttons	<p>Begin: Move at the beginning of the recorded video file.</p> <p>Previous: Go back to the previous frame.</p> <p>Slower: Play the recorded video file at the speed of 1/2x, 1/4x, or 1/8x.</p> <p>Rewind: Wind back the recorded video file.</p> <p>Pause: Briefly stop playing the recorded video file.</p> <p>Play: Play the recorded video file.</p> <p>Faster: Play the recorded video file at the speed of 2x, 4x, or 8x, 16x or 32x.</p> <p>Next: Go to the next frame.</p> <p>End: Go to the end of the recorded video file.</p>
(5) Date	Select the date on the calendar and the time from 00 to 23 to where to start playing the recorded video file.
	The numbers from 00 to 23 represent the time in 24-hour clock. The numbers from 01 to 16 represent the camera ID. The blue colored column indicates that there is a recorded video file on that period of time. While the red colored column indicates on where to start playing the recorded video file.
(6) Preview	Switch to Preview/Advanced mode.
(7) Playback	Switch to Playback mode. This allows you to view the recorded video file.
(8) Status bar	Display the recorded date, time and play speed.
(9) Camera ID	Show the number of cameras that are being viewed. When you are in single screen mode, click the camera ID number to switch and view other camera.
(10) Export	<p>Export includes Snapshot, Print, Output Video Clip, and Backup function.</p> <ul style="list-style-type: none"> ■ Snapshot: Capture and save the screen shot either in *.jpg or *.bmp format. ■ Print: Print the screen shot. ■ Output Video Clip: Save the segmented file in *.mpg, *.avi, or *.dvr format (see also Chapter 4.8). ■ Backup: Save the playback file to USB device or DVD-ROM disk(see also Chapter 5.6 Backup Setting)
(11) Segment	Keep a portion of the recorded video you want (see also Chapter 4.8).
(12) Full screen	View in Playback-compact mode. To return, press the right button of the mouse or ESC on the keyboard. When you switch to full screen in multiple-screen mode, Left click to toggle to only display one of the video in the multiple-screen mode or all.
(13) Visual Search	Search from a specific camera by Date, Hour, Minute, 10 Seconds and Second. (See also Chapter 4.10)
(14) Find Next	Search for the next event or changes in the motion detector frame. You can use this when you are using Intelligent Search or Event Search function.
(15) Intelligent Search	Search the changes in the motion detector frame (See also Chapter 4.12).
	The Visual and Intelligent search only available when the remote site is recording and playback from remote local hard disk.

8.5.2 Familiarizing the RealTime Playback Buttons





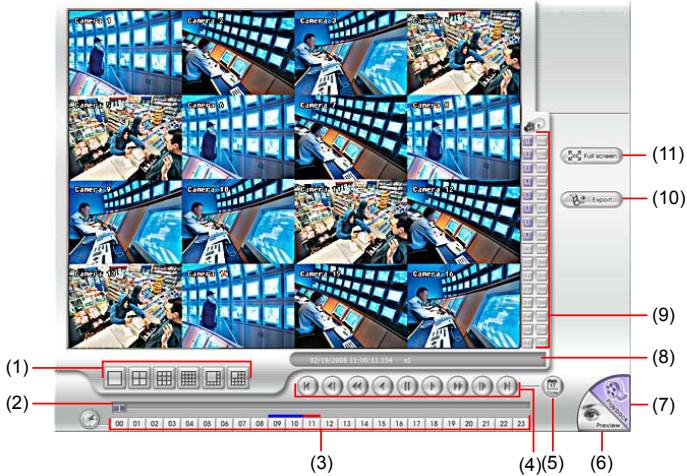

Name	Function
(1) Split Screen Mode	Select from 2 different split screen type to playback the recorded video file of all the camera, or one camera. To view all channels, click 4 split screen button to switch channel display.
 <ul style="list-style-type: none"> - If there are only 4 cameras, you won't be able to switch to 9, 16, and 13 split screen mode. - To zoom in an area on the screen, Right click and Drag a square on the area you want to enlarge. 	
(2) Progress bar	Show the progress of the file being played. You may move the bar to seek at any location of the track.
(3) Hour Buttons	Select and click to playback the recorded video file on the specific time frame.
	The Hour buttons represent the time in 24-hour clock. The blue bar on top of the hour button indicates that there is a recorded video file on that period of time. While the red bar indicates that you are currently viewing the recorded video file.
(4) Playback Control Buttons	<p>Begin: Move at the beginning of the recorded video file.</p> <p>Previous: Go back to the previous frame.</p> <p>Slower: Play the recorded video file at the speed of 1/2x, 1/4x, or 1/8x.</p> <p>Rewind: Wind back the recorded video file.</p> <p>Pause: Briefly stop playing the recorded video file.</p> <p>Play: Play the recorded video file.</p> <p>Faster: Play the recorded video file at the speed of 2x, 4x, or 8x, 16x or 32x.</p> <p>Next: Go to the next frame.</p> <p>End: Go to the end of the recorded video file.</p>

Name	Function
(5) Date	Select the date on the calendar and the time from 00 to 23 to where to start playing the recorded video file.
	<p>The numbers from 00 to 23 represent the time in 24-hour clock. The numbers from 01 to 16 represent the camera ID. The blue colored column indicates that there is a recorded video file on that period of time. While the red colored column indicates on where to start playing the recorded video file.</p>
(6) Preview	Switch to Preview/Advanced mode.
(7) Playback	Switch to Playback mode. This allows you to view the recorded video file.
(8) Status bar	Display the recorded date, time and play speed.
(9) Camera ID	Show the number of cameras that are being viewed. When you are in single screen mode, click the camera ID number to switch and view other camera.
(10) Snapshot	Capture and save the screen shot either in *.jpg or *.bmp format.
(11) Full screen	<p>View in Playback-compact mode. To return, press the right button of the mouse or ESC on the keyboard.</p> <p>When you switch to full screen in multiple-screen mode, Left click to toggle to only display one of the video in the multiple-screen mode or all.</p>

8.5.3 Familiarizing the Download and Playback Buttons



Name	Function
(1) Split Screen Mode	Select from six (6) different split screen types to playback the recorded video file of all the camera, or one camera over the other or alongside on a single screen.
	<ul style="list-style-type: none"> - If there are only 4 cameras, you won't be able to switch to 9, 16, and 13 split screen mode. - To zoom in an area on the screen, Right click and Drag a square on the area you want to enlarge.
(2) Progress bar	Show the progress of the file being played. You may move the bar to seek at any location of the track.
(3) Hour Buttons	Select and click to playback the recorded video file on the specific time frame.
	The Hour buttons represent the time in 24-hour clock. The blue bar on top of the hour button indicates that there is a recorded video file on that period of time. While the red bar indicates that you are currently viewing the recorded video file.
(4) Playback Control Buttons	<p>Begin: Move at the beginning of the recorded video file.</p> <p>Previous: Go back to the previous frame.</p> <p>Slower: Play the recorded video file at the speed of 1/2x, 1/4x, or 1/8x.</p> <p>Rewind: Wind back the recorded video file.</p> <p>Pause: Briefly stop playing the recorded video file.</p> <p>Play: Play the recorded video file.</p> <p>Faster: Play the recorded video file at the speed of 2x, 4x, or 8x, 16x or 32x.</p> <p>Next: Go to the next frame.</p> <p>End: Go to the end of the recorded video file.</p>

Name	Function
(5) Date	Select the date on the calendar and the time from 00 to 23 to where to start playing the recorded video file.
	The numbers from 00 to 23 represent the time in 24-hour clock. The numbers from 01 to 16 represent the camera ID. The blue colored column indicates that there is a recorded video file on that period of time. While the red colored column indicates on where to start playing the recorded video file.
(6) Preview	Switch to Preview/Advanced mode.
(7) Playback	Switch to Playback mode. This allows you to view the recorded video file.
(8) Status bar	Display the recorded date, time and play speed.
(9) Camera ID	Show the number of cameras that are being viewed. When you are in single screen mode, click the camera ID number to switch and view other camera.
(10) Export	<p>Export includes Snapshot, Print, Output Video Clip, and Backup function.</p> <ul style="list-style-type: none"> ■ Snapshot: Capture and save the screen shot either in *.jpg or *.bmp format. ■ Print: Print the screen shot. ■ Output Video Clip: Save the segmented file in *.mpg, *.avi, or *.dvr format. Follow the below steps to output a video clip: <ol style="list-style-type: none"> 1. Use the Playback Control buttons or drag the bar on the playback progress bar and pause on where you want to start the cut. Then, click Segment to set the begin mark.  <ol style="list-style-type: none"> 2. Use the Playback Control buttons or drag the bar on the playback progress bar and pause on where you want to end the cut. Then, click Segment to set the end mark. To cancel segmentation or set the segment marks from the start, click Segment button again.  <ol style="list-style-type: none"> 3. Click Output button to save the wanted clip. 4. In the Save As dialog box, locate on where you want to save the file, type the filename, and select the video format.
(11) Full screen	<p>View in Playback-compact mode. To return, press the right button of the mouse or ESC on the keyboard.</p> <p>When you switch to full screen in multiple-screen mode, Left click to toggle to only display one of the video in the multiple-screen mode or all.</p>

8.6 Using HandyViewer to Access DVR server

Users can use a mobile phone to access the DVR through Internet. Make sure your mobile phone support IE browser and is connected to the internet. To access the DVR server, open IE browser and enter **http://enter server IP or domain name here/mobile**. You can see the latest screen shot. Click << >> to change the channel or camera and **Refresh** to reload new screen shot.

8.7 Using PDAViewer to Access DVR Server

Users can also use a PDA to access the DVR through Internet. Make sure your PDA support IE browser and is connected to the internet. To use this feature, you need to install the

PDAViewer software either thru ActiveSync connection or download it from the internet. Please check if your PDA meets the 2 requirements below.

OS: MS Windows CE 4.0, PocketPC 2002/2003, Mobile 5 PDA version
CPU: ARM architecture

8.7.1 To install PDAViewer thru ActiveSync

1. Connect your PDA to your PC. Place the CD into the CD-ROM drive then click Install PDAViewer. And follow the on screen instructions.



2. Click **Next** to continue.

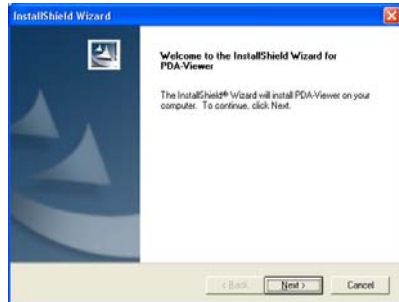

3. Read the license agreement and click **Yes** to accept all the terms. The system will then automatically install the application.

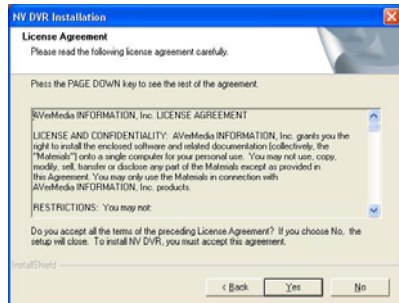

4. When you are prompted, click **Yes** to install the application using the default directory.

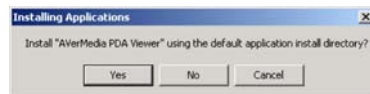

5. When done, click **OK**.



8.7.2 To install PDAViewer from the Internet

Make sure you are connected to the internet.

1. Open the web browser and enter the server IP. Then click the hyperlink **Download PDA-Viewer**.



2. When the Download dialog box appears, enable **Open file after download** and click **Yes**.



After the installation, the PDA-Viewer 5.5 icon will appear in the Programs list.

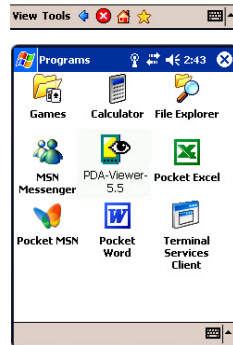

8.7.3 To Use the PDAViewer

1. Run the **PDAViewer 5.5** in the Programs.
2. Familiarizing the PDAViewer buttons.

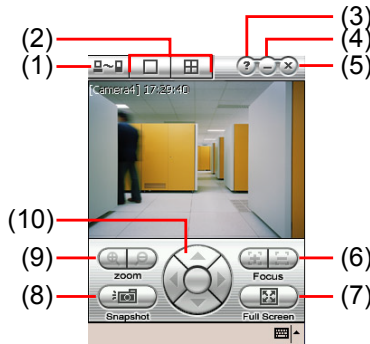

Name	Function
------	----------

- | | |
|-------------|---|
| (1) Connect | Hook up to the NV DVR server. Make sure you are connected to internet.
When the iView screen appears, click Add to add DVR server. |
|-------------|---|

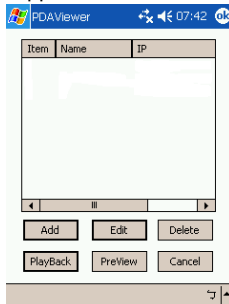

Enter the server IP, port, user ID, password and select the connection type. Then, click **OK**.

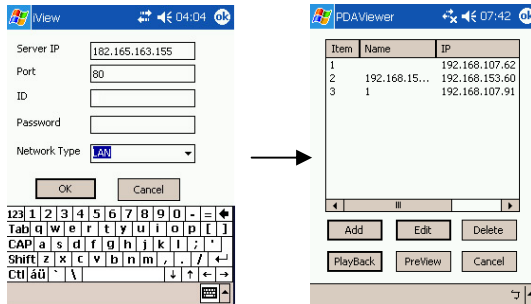

User can playback the recorded video from remote DVR server in PDAViewer.(see [Chapter 8.6.4](#))

(2) Split Screen Mode	Select between 2 screen display types. It also allows you to switch and view different camera number or channels.
(3) About	Display the PDAViewer software version.
(4) Minimize	Reduce the size to taskbar.

Name	Function
(5) Exit	Close the PDAViewer.
(6) Focus	Adjust the focus of PTZ camera to produce clear image.
(7) Full Screen	Use the entire screen to only display the video.
(8) Snapshot	Capture and save the screen shot in *.bmp format.
(9) Zoom	Zoom in and out the PTZ camera image.
(10) Direction buttons	Adjust and position the focal point of the PTZ camera.

- To change the video quality, enable/disable audio, and select to display different camera, tap on the video screen longer the pop up menu will appear.



8.7.4 To Playback in PDAViewer

- Run the **PDAViewer** in the Programs.
- Hook up to the NV DVR server.
- Click **Connect** icon and select the DVR server
- Click **Playback** to enter playback option screen
- Select the **camera, data, and time**
- Click **Playback** to start playing the recorded video

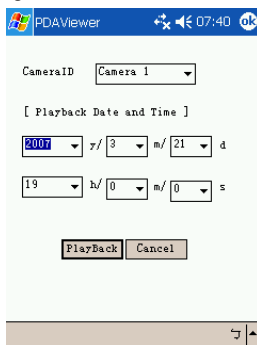

- While playback, user can view and change status of I/O devices
- On the playback screen, tap on video screen longer the pop up menu will appear
- Select the **Remote IO**

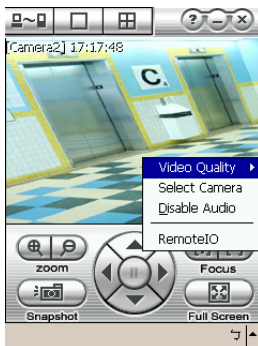

10. The sensor and relay devices will list as below:

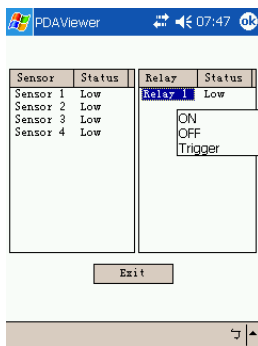

11. User can change the relay status. Select the relay and tap on video screen longer the pop up menu will appear, and then, select the status (ON, OFF, Tigger)

8.8 Using JavaViewer to Access DVR Server

Using the mobile phone within Symbian Smart Phone OS to access the DVR through Internet. Make sure your mobile phone supports Symbian Smart Phone OS and can be connected to the internet. To use this feature, you need to install the JAVAVIEWER program that it can be downloading it from the DVR server through the internet.

8.8.1 To install JAVAVIEWER from the DVR Server

1. Open the web browser and enter the DVR server IP (http://DVR server IP: port/JAVAVIEWER.html). Then click **Connect**.
2. When the Download screen appears, select **JAVAVIEWER.jad** and download it to your mobile phone.
3. After the installation, the JAVAVIEWER will be in your mobile phone system. To find the JAVAVIEWER program where is located, please refer to your mobile phone user's manual.

8.8.2 To Use the JAVAViewer

1. Run the JAVAViewer program.
2. Enter the DVR IP address, port number, user ID, and password. Please refer to your DVR server setting for that information.
3. And then, select the Connect to connect to DVR server.
4. Click **Yes** to accept the data from DVR server.
5. When connection is success, you will see the camera video on the screen.



6. To switch to different camera view, select menu and select the channel.



7. The JAVA-Viewer support PTZ control function, you can refer to **Help** file for detail function control key. Select **menu** and go the way down to select the **Help** file.



Chapter 9 Image Verification

ImageVerification is a watermark-checking program to identify the authenticity of a saved image (e.g. by snapshot). This program can only verify uncompressed bmp image files.

9.1 To Run the ImageVerification program

1. Click **Start>Programs>DSS>ImageVerification**.
2. In the ImageVerification screen, click **Load Source Image** and locate the image source.
3. Click **Verify Image** to begin the process.
4. Check the result in the Processed Image screen. If the picture is unmodified, the image in the Source Image and Processed Image screen would be exactly the same. If the picture is being modified, a warning dialog box would prompt you and the modified area is highlighted.

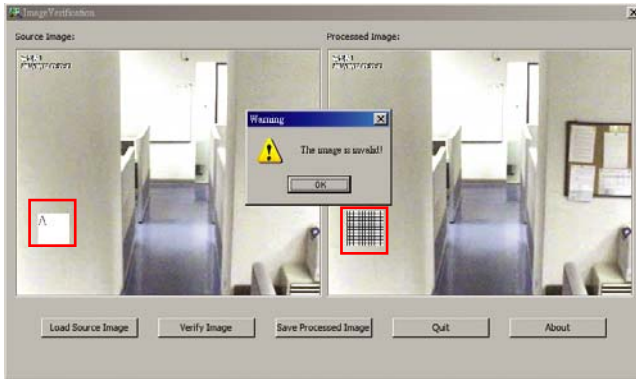

Chapter 10 iEnhance

The bundled iEnhance is a video editing tool and can only be used with *.dvr video file. It allows you to adjust the video picture quality, segment and save the wanted portion of the video, zoom in and out the image, and print or save the screen shot. You can also save the setting and apply it on other files.

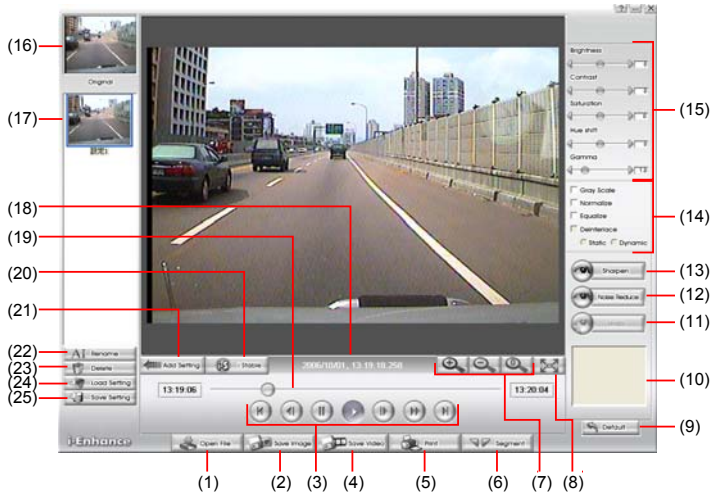

Name	Function
(1) Open File	Access *.dvr video file.
(2) Save Image	Capture and save the screen shot in *.bmp format.
(3) Playback Control Buttons	Begin: Move to the beginning of the video file. Previous: Go back to the previous frame. Pause: Briefly stop playing the video file. Play: Play the video file. Faster: Play the video file at faster speed Next: Go to the next frame. End: Go to the end of the video file.
(4) Save Video	Save the edited or segmented video in *.avi format.
(5) Print	Print the screen shot.
(6) Segment	Mark the beginning and the end of the wanted portion of the video. Two triangle marks will appear on the slider. To cancel video segmentation, click this button again.
(7) Zoom Buttons	Enlarge, reduce, and set the image back to normal size.
(8) Full Screen	Use the entire screen to only display the video.
(9) Default	Set the video back to original state and delete all the changes in the history box.
(10) History Box	List all the actions.
(11) Undo	Delete the last action.
(12) Noise Reduce	Adjust the softness and repair the damaged colours.
(13) Sharpness	Improve the overall image by enhancing edges. This gives the image more depth.

Name	Function
(14) Effects	<ul style="list-style-type: none"> • Gray Scale: convert the image into black and white (monochrome). • Normalize: adjust the brightness intensity. • Equalize: automatically adjust the images that are too dark. • De-interlace: smooth out the overlying frames. • Static: de-interlace for motionless scene. • Dynamic: de-interlace for moving scene.
(15) Picture Adjustment	Adjust the Brightness, Contrast, Saturation, Hue and Gamma.
(16) Original Screen	Display the original state of the image.
(17) Temporary Setting Block	Display the sample settings. Click the sample to apply the setting on the current video.
(18) Status Bar	Display the date, and time of the video.
(19) Progress Bar	Show the progress of the file being played. You may move the bar to seek at any location of the track.
(20) iStable	To reduce the jolt in the recorded video.(also see Chapter 10.1)
(21) Add Setting	Include the new setting to the temporary setting block.
(22) Rename	Change the name of the selected setting in the temporary setting block.
(23) Delete	Permanently remove the selected setting in the temporary setting block.
(24) Load Setting	Call the saved settings.
(25) Save Setting	Store the settings in the temporary setting block.

10.1 To Use iStable

The iStable function can reduce the jolt in the recorded video.

1. Click Open File button and select the recorded video.
2. And then, click iStable button.
3. iStable windows will show up.
4. Select the smoothness level – 1(Low), 2, 3, 4, and 5(High). The default value is 3.
5. Click Play button, and then i-Stable function will start to initial the recorded video.
6. When the initialize is done, user will see the original and stabilized recorded video play in two windows.

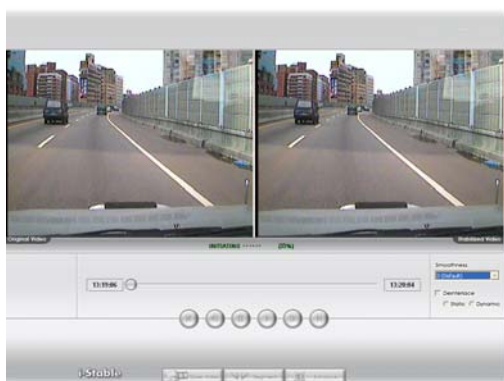

Chapter 10 iEnhance

7. While the video is playing, user can select a portion of video to play and save. Use the Playback Control buttons or drag the bar on the playback progress bar and pause on where you want to start the cut. Then, click **Segment** to set the begin mark. And, Use the Playback Control buttons or drag the bar on the playback progress bar and pause on where you want to end the cut. Then, click **Segment** to set the end mark. To cancel segmentation or set the segment marks from the start, click **Segment** button again.
8. Click **Save Video** button to save the wanted clip.
9. In the Save As dialog box, locate on where you want to save the file, type the filename, and select the video compress mode – Optimize for speed or Optimize for storage.

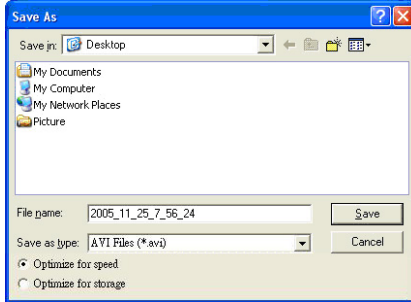

10. To switch back to iEnhance interface, click **iEnhance** button

Chapter 11 Web Tools

The bundled Web Tools includes Dispatch Server and Remote Backup program. To install Web Tools, place the CD into the CD-ROM drive then click **Install Web Tools**.



11.1 Dispatch Server

Dispatch is designed to reduce the network traffic of the DVR server. Instead of connecting directly to the DVR server, the client can connect to the computer that is connected to the DVR server using the Dispatch program.

To Run Dispatch program:

1. Make sure you are connected to the internet.
2. Click **Start>Programs>DSS>Tool>Dispatch**.
3. In the DVR Server section, enter the DVR server IP, port, user ID and password. You can also select to display the language you prefer.

4. **Auto connect when start**

Enable to automatically connect the dispatch server when start up

5. In the **Dispatch Service** section, if you have installed more than one network card, select the Service IP number.
6. In the **Dynamic DNS Configuration** section, enter the DNS server Name and Password. The DNS server can be the remote storage server for sharing the DVR system loading.
7. Click **START** to connect.

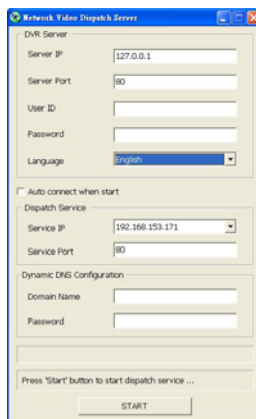

11.2 Remote Backup

Remote Backup is purely for backing up the *.dvr file from the DVR sever. You can select between Auto Backup and Manual Backup. Auto Backup continuously archives one hour of the

Chapter 11 Web Tools

recorded data at a time, starting from the specified date. As for Manual Backup, it only archives the recorded data of selected date.



To back up the data, you must have at least 2G hard disk space.

To back up the recoded data from the DVR server:

1. Make sure you are connected to the internet.
2. Click **Start >> Program >> DSS >> Tool >> Remote Backup**
3. To add the DVR server, click **Add**

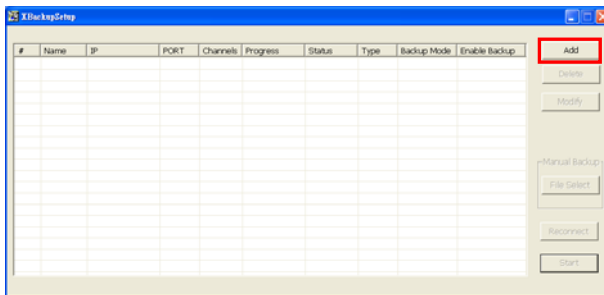

4. In the Add New DVR windows, enter the Name, IP, user ID, and password.

5. Select the Backup mode:

Auto Backup mode: the backup will automatically execute when the setup is completed

- In Begin Date drop down calendar, select the date from where to start
- Click **Add** to set the storage path.
- Click **Delete** to remove the selected storage path.
- Click **Schedule** to select/unselect the time you want to backup. The red block turns white when it is unselected.
- Enable/disable **Disk Recycle** check box, to automatically overwrite the oldest file when there is not enough free space to backup the file.

Manual Backup mode: the backup progress will start when user press the backup button

- Click **File Select** to choose the date, time and camera you want to back up.
 - Click **Browse** to set the storage path.
6. Click **OK** to complete the adding DVR server. The added DVR server will display in Remote Backup main windows.

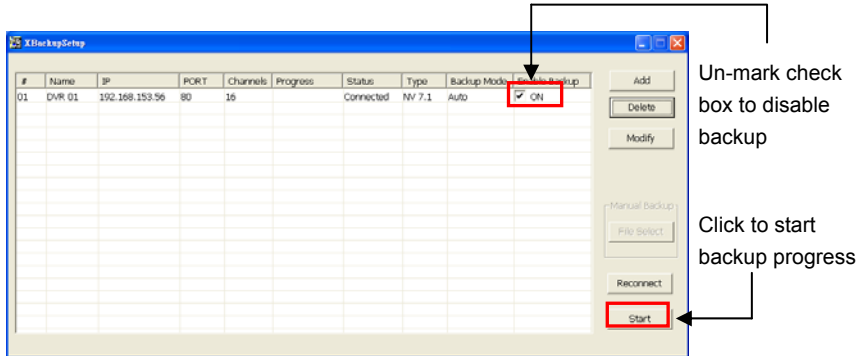

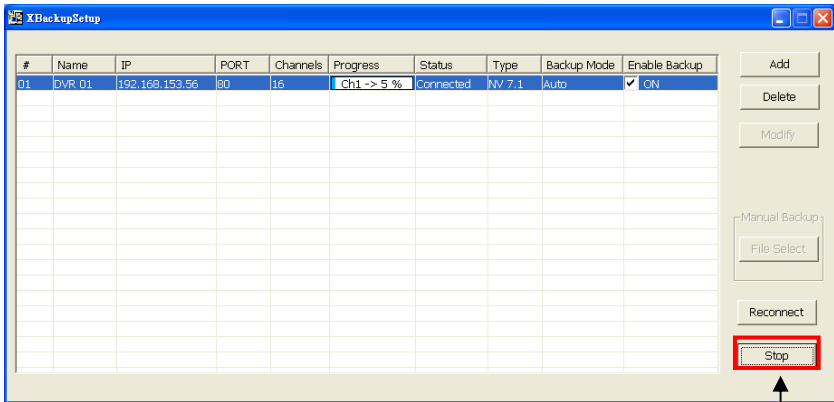

7. Click **Start** to begin backup and click Stop to stop backup progress.



While backup, the **start** button will turn to **stop** button

8. For manually backup, click **file select** button and select the DVR wants to backup.

Chapter 12 Using the Remote Control Server

The bundled Remote Control Server enables the PC with Central Management System program (CM3000) installed in it remotely access the DVR server. You may need to manually run this program for CMS access the DVR server. To run, click **Start > Programs > DSS > DVR > Remote Control Server**. The  remote control server icon appears on the taskbar when the remote control server is enabled. To change the port setting or stop server, right-click  icon and then make a selection.

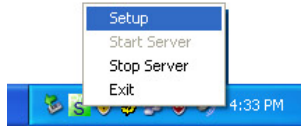

User can also setup Remote Control Server in DVR **Network** setting, please see [Chapter 5.4 #\(5\)](#).

Appendix A Registering Domain Names

DDNS (Dynamic Domain Name Service) is a data query service mainly used on the Internet for translating domain names into Internet addresses. It allows remote clients to intelligently search dynamic servers without any previous enquiring for servers' Internet addresses.

In order to take advantage of this intelligent service, first register your domain name on the following Web site <http://ddns.avers.com.tw>

1. User Login

Browse the website ddns.avers.com.tw with Microsoft IE or Netscape Navigator to access the following dialog.

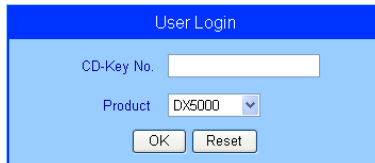

The 'User Login' dialog box has a blue header and a light blue body. It contains a text input field for 'CD-Key No.', a dropdown menu for 'Product' with 'DX5000' selected, and two buttons: 'OK' and 'Reset'.

- First input CD-key number (serial number) and select the product name.
- Then click **OK** to login or **Reset** to clear the previous input.

2. User Information

Please provide the following user information, **Host Name** (user can choose any name he/she likes except the one violence with other users), **Password**, **E-mail**, **Company**, and **Country**. And then, click **OK** to complete the domain name registration.

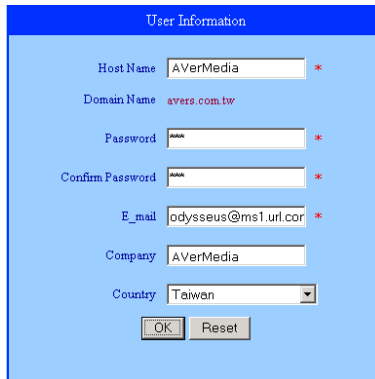

The 'User Information' dialog box has a blue header and a light blue body. It contains several fields: 'Host Name' (AVerMedia), 'Domain Name' (avers.com.tw), 'Password' (masked with asterisks), 'Confirm Password' (masked with asterisks), 'E_mail' (odysseus@ms1.url.cor), 'Company' (AVerMedia), and 'Country' (Taiwan). There are 'OK' and 'Reset' buttons at the bottom.



Note that Host Name and Domain Name (AVerMedia.avers.com.tw) are the replacement for Internet address while a remote client tends to search a dynamic server.

Appendix B Configure UPnP

DVR application support UPnP function that can automatically configure the port setting to the local router.

Please make sure the following items are true for the UPnP to work able:

- Window XP service Pack 2 is require
- Window XP must be configured to use UPnP
- UPnP must be enabled on your router (Please contact your local router dealer or refer to the router user manual for the UPnP configuration on router)

Enabling UPnP in Window XP

1. Go to **Start > Setting > Network Connections**. And then, the below windows appear:

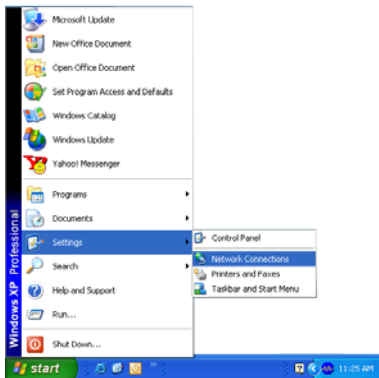

2. Right click on **Local Network Connection** icon and select **Properties > Advance** tab. The below windows appear:

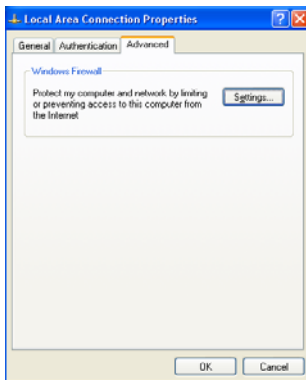

3. Click **Settings** button and select **Exception** tab. The **Windows Firewall** appears.

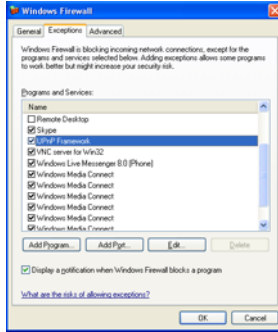

4. Mark the **UPnP Framework** check box and click **OK**.

Appendix C Network Service Port

The following table shows the ports that DVR server uses for certain network service.

	Port #	Variable
Remote Console (CM 3000)	5550	Y
WebCam	80	Y
2-way audio	9999	Y
Remote Control (CM3000/RC1000)	5555	Y
DVR POS	5150	Y
DVR DDNS (Upload / Download)	53 / 1053	N

LIMITED WARRANTY

AVerMedia INFORMATION, Inc. warrants that this product to be free of defects resulting from faulty manufacturing or components under the following terms:

WARRANTY LENGTH

Labor is warranted for 15 months from the date of purchase. Replacement products will be warranted for the remainder of the 15-month warranty period or 30 days, whichever is longer.

WHO IS PROTECTED

This warranty is enforceable only by the first consumer purchaser.

WHAT IS AND IS NOT COVERED

Except as specified below, this warranty covers all defects resulting from faulty manufacturing of this product. The following are not covered by the warranty.

1. Any product on which the serial number has been defaced, modified, or removed.
2. Damage, deterioration, or malfunction resulting from:
 - a. Accident, abuse, misuse, neglect, fire, water, lightning, or other acts of nature, commercial or industrial use, unauthorized product modification, or failure to follow instructions included with the product.
 - b. Misapplication of service by someone other than the manufacturer's representative.
 - c. Any shipment damages. (Claims must be made with carriers.)
 - d. Any other cause that does not relate to a product defect.
3. Cartons, cases, batteries, cabinets, tapes, or accessories used with the product.
4. AVerMedia INFORMATION, Inc. does not warrant that this product will meet your requirements; it is your responsibility to determine the suitability of this product for your purpose.

WHAT WE WILL AND WILL NOT PAY FOR

We will pay labor and material expenses for covered items. However, we will not pay for the following:

1. Removal or installation charges.
2. Shipping charges.
3. Any incidental charges.

EXCLUSION OF DAMAGES

THE MANUFACTURER'S SOLE OBLIGATION AND LIABILITY UNDER THIS WARRANTY IS LIMITED TO THE REPAIR OR REPLACEMENT OF A DEFECTIVE PRODUCT AT OUR OPTION. THE MANUFACTURER SHALL NOT, IN ANY EVENT, BE LIABLE TO THE PURCHASER OR ANY THIRD PARTY FOR ANY INCIDENTAL OR CONSEQUENTIAL DAMAGE (INCLUDING, BUT NOT LIMITED TO, DAMAGES RESULTING FROM INTERRUPTION OF SERVICE AND LOSS OF BUSINESS) OR LIABILITY LIMITATIONS OF IMPLIED WARRANTIES.

There are no other oral or written warranties, expressed or implied, including but not limited to those of merchantability or fitness for a particular purpose. Any implied warranties are limited in duration to 15 months from the date of purchase.

STATE LAW AND YOUR WARRANTY

This warranty gives you specific legal rights, and you may also have other rights granted under state law. These rights vary from state to state.

CONTACT INFORMATION

Taiwan & International
FL 5th, No. 137, Jian Yi Rd., Chung Ho City, Taipei, Taiwan
TEL: 886-2-2226-3630#2582
FAX: 886-2-2226-7241
Web Site: www.averdigi.com